

"HIGH PERFORMANCE 4WD COMPONENTS"

PRODUCT CATALOGUE 2025

Ver: 2025.03.18



WCS
WEST COAST
SUSPENSIONS

Since 1924

100
YEARS

Tel: +61 8 9378 2133

Fax: +61 8 9378 2839

Email: sales@jenkins.com.au

Web: www.westcoastsuspensions.com.au



CONTENTS

DAIHATSU	3
DODGE	5
FORD	6
GREAT WALL MOTORS	15
HOLDEN	19
ISUZU	24
JEEP	29
LAND ROVER	33
LDV	35
MAZDA	37
MITSUBISHI	41
NISSAN	47
SUZUKI	59
TOYOTA	63
VOLKSWAGEN	86
COIL SPRING SPECIFICATIONS	87
SHOCK ABSORBER REFERENCE CHART	88
STEERING DAMPER REFERENCE CHART	90
4WD SHACKLE BUSH KITS	91
4WD SUSPENSION U-BOLT DIMENSIONS	92
LEAF SPRING SPECIFICATIONS	93
SUSPENSION INSTALLATION FORM	95
WARRANTY ASSESSMENT FORM	96
WARRANTY TERMS AND CONDITIONS	97
MONOTUBE REMOTE RESERVOIR	98
MONOTUBE	101
TWINTUBE	103
UPPER CONTROL ARM (UCA'S)	104







© West Coast Suspensions 2024





All rights reserved. No part of this publication may be reproduced or utilised in any form or by any means, electronic or mechanical, including photocopying, recording or by any information storage and retrieval systems, without the prior written permission of the publishers.

Disclaimer

The preparation of this catalogue has been carried out with every care and attention, however, West Coast Suspensions accepts no responsibility.

Make: DAIHATSU
Model: ROCKY HARDTOP, F70, F75, F80RV, F85RV





Front Suspension				
Description		Part #	Qty	Notes
Leaf Spring		DAT 03	2	6 leaf spring to 45kg constant
Shock Absorber		G36-5483	2	Gas charged
Bush Kit		UK711	1	Urethane bush kit
U/Bolt		UB659	1	Driver's side inner
		UB658	3	Round top U-bolt

Rear Suspension				
Description		Part #	Qty	Notes
Leaf Spring		DAT 04	2	6 (5+1) leaf constant 100kg
Shock Absorber		G36-5483	2	Gas charged
Bush Kit		UK710	1	Urethane bush kit
U/Bolt		UB658	4	Round top U-bolt



Make: DAIHATSU

Model: ROCKY TRAYBACK, F77P, F77R



Front Suspension

Description		Part #	Qty	Notes
Leaf Spring		DAT 03	2	6 leaf spring to 45kg constant
Shock Absorber		G36-5483	2	Gas charged
Bush Kit		UK711	1	Urethane bush kit
U/Bolt		UB659	1	Driver's side inner
		UB658	3	Round top U-bolt

Rear Suspension

Description		Part #	Qty	Notes
Leaf Spring		DAT 06	2	6 (5+1) leaf constant 100kg
Shock Absorber		G36-5593	2	Gas charged
Bush Kit		UK707	1	Urethane bush kit
U/Bolt		UB437A	4	Square top U-bolt



Make: DODGE
Model: RAM 1500 (DS MODEL ONLY)

Front Suspension				
Description		Part #	Qty	Notes
Coil Spring		DRM 100	1 pair	Up to 100kg constant *coil will NOT fit OE strut
		DRM 100HD	1 pair	100kg - 150kg constant *coil will NOT fit OE strut
Monotube Shock Absorber		MG-0636G50	2	Gas charged strut







Rear Suspension				
Description		Part #	Qty	Notes
Coil Spring		DRM 110HD	2	Up to 100kg constant
Monotube Shock Absorber		MG-0036P	2	Gas charged

Make: FORD
Model: COURIER '86-'06, 4WD (REF MAZD001K)

Front Suspension

Description		Part #	Qty	Notes
Torsion Bar		TB1546	1 pair	26mm Ø x 927mm
Shock Absorber		G36-5535	2	Gas charged

Rear Suspension

Description		Part #	Qty	Notes
Leaf Spring		MAZD 01	2	7 (5+2) leaf constant 250kg
		MAZD 01HD	2	8 (6+2) leaf constant 450kg
Shock Absorber		G36-5522	2	Gas charged
Bush Kit		UK756	1	Urethane bush kit
Fixed Pin		SP794G	2	Greasable pin
Shackle		SK386/1G	2	Greasable shackle
U/Bolt		UB415	4	Round top U-bolt





Make: FORD

Model: RANGER PJ-PK 4WD 2006 - 10/2011 (REF MAZD002K)

Front Suspension

Description		Part #	Qty	Notes
Torsion Bar		TB1551	1 pair	27mm Ø x 1024mm
Shock Absorber		G36-5535	2	Gas charged







Rear Suspension

Description		Part #	Qty	Notes
Leaf Spring		MAZD 02	2	6 (4+2) leaf constant 300kg
		MAZD 02HD	2	7 (5+2) leaf constant 500kg
Shock Absorber		G36-5522	2	Gas charged
Bush Kit		UK769	1	Urethane bush kit
Fixed Pin		SP385/1	2	14mm pin
Shackle		SK386/1G	2	Greasable shackle
U/Bolt		UB473	4	Round top U-bolt

Make: FORD

Model: RANGER PX/PX2 4WD & 2WD HI-RIDER 10/2011 - 8/2018 (REF MAZD003K)

Front Suspension

Description		Part #	Qty	Notes
Coil Spring		MAZD 100SH	1 pair	To 70kg constant - std > 20mm
		MAZD 100	1 pair	To 70kg constant > 50mm
		MAZD 100HD	1 pair	70kg - 120kg constant > 50mm
Shock Absorber		G38-5650	2	Gas charged strut
Monotube Remote Reservoir Shock Absorber		MXA5-1603A50	2	High performance 46mm gas charged adjustable 8 stage
Strut Cap		10-1085	2	Replacement strut top cap
Strut Spacer		10-1091	2	6mm thick for trimming or raising vehicle
Upper Control Arms		UCAB02-01-0	1 pair	







Rear Suspension

Description		Part #	Qty	Notes
Leaf Spring		MAZD 03	2	6 (4+2) leaf constant 300kg
		MAZD 03GVM	2	7 (5+2) leaf constant 500kg
Shock Absorber		G36-5522	2	Gas charged
Monotube Remote Reservoir Shock Absorber		MPA5-4045PL	1	Left side piggy back
		MPA5-4045PR	1	Right side piggy back
Bush Kit		UK770	1	Urethane bush kit
Fixed Pin		SP385/1	2	14mm pin
Shackle		SK389G	2	Greasable shackle
U/Bolt		UB473	4	Round top U-bolt
Centre Bearing Spacer		CBS01	1	Helps reduce tail shaft vibration

Make: FORD

Model: RANGER PX3 4WD (excluding Raptor) 9/2018 - 6/2022 (REF FORD002K)

Front Suspension







Description		Part #	Qty	Notes
Coil Spring		FORD 100	1 pair	Up to 55kg constant
		FORD 100HD	1 pair	55kg - 85kg constant
Shock Absorber		G38-5651	2	Gas charged strut
		BSBK-24	2	Bump stop kit
Monotube Remote Reservoir Shock Absorber		MXA5-1611A50L	1	Left side adjustable 8 stage
		MXA5-1611A50R	1	Right side adjustable 8 stage
Strut Cap		10-1081	2	Replacement strut top cap
Strut Spacer		10-1091	2	6mm thick for trimming or raising vehicle
Upper Control Arms		UCAB02-01-0	1 pair	







Rear Suspension

Description		Part #	Qty	Notes
Leaf Spring		MAZD 03	2	6 (4+2) leaf constant 300kg
		MAZD 03GVM	2	7 (5+2) leaf constant 500kg
Shock Absorber		G36-5522	2	Gas charged
Monotube Remote Reservoir Shock Absorber		MPA5-4045PL	1	Left side piggy back
		MPA5-4045PR	1	Right side piggy back
Bush Kit		UK770	1	Urethane bush kit
Fixed Pin		SP385/1	2	14mm pin
Shackle		SK389G	2	Greasable shackle
U/Bolt		UB473	4	Round top U-bolt
Centre Bearing Spacer		CBS01	1	Helps reduce tail shaft vibration





Make: FORD

Model: RANGER PY 4WD (excluding Raptor) 7/2022 on (REF FORD006K)

Front Suspension				
Description		Part #	Qty	Notes
Coil Spring		FORD 101L	1 pair	2lt Bi Turbo
		FORD 101	1 pair	2lt HD or V6
		FORD 101HD	1 pair	V6 HD
Shock Absorber		G38-5652	2	Gas charged strut
		BSBK-25	2	Bump stop kit
Monotube Remote Reservoir Shock Absorber		MXA5-1615A75L	1	Left side adjustable 8 stage
		MXA5-1615A75R	1	Right side adjustable 8 stage
Strut Cap		10-1080	2	Replacement strut top cap
Strut Spacer		10-1091	2	6mm thick for trimming or raising vehicle
Upper Control Arms		UCAB02-04-0	1 pair	Steel knuckle XL & XLS models only
		UCAB02-05-0	1 pair	Aluminium knuckle XLT, Wildtrack & Platinum





Rear Suspension				
Description		Part #	Qty	Notes
Leaf Spring		FORD 01	2	5 (4+1) leaf constant 300kg
		FORD 01HD	2	6 (5+1) leaf constant 400kg
		FORD 01EHD	2	7 (6+1) leaf constant 500kg
Shock Absorber		G36-5566	2	Gas charged
Monotube Remote Reservoir Shock Absorber		MXA5-1015P75L	1	Left side adjustable 8 stage
		MXA5-1015P75R	1	Right side adjustable 8 stage
Bush Kit		UK770	1	Urethane bush kit
Fixed Pin		SP385/1	2	14mm pin
Shackle		SK389G	2	Greasable shackle
U/Bolt		UB437A	4	Square top U-bolt
		UB437	4	Square top U-bolt use with FORD01HD & EHD
Centre Bearing Spacer		CBS03	1	Helps reduce tail shaft vibration

Make: FORD
Model: EVEREST UA 4WD 2016 - 6/2018 (REF FORD003K)

Front Suspension				
Description		Part #	Qty	Notes
Coil Spring		MAZD 100	1 pair	Up to 55kg constant
		MAZD 100HD	1 pair	55kg - 85kg constant
Shock Absorber		G38-5650	2	Gas charged strut
Strut Cap		10-1085	2	Replacement strut top cap
Strut Spacer		10-1091	2	6mm thick for trimming or raising vehicle
Upper Control Arms		UCAB02-01-0	1 pair	

Rear Suspension				
Description		Part #	Qty	Notes
Leaf Spring		FORD 106	1 pair	Constant 100kg
		FORD 106HD	1 pair	Constant 250kg
Shock Absorber		G36-5601	2	Gas charged





Make: FORD
Model: EVEREST UA2 4WD 7/2018 - 6/2022 (REF FORD004K)



Front Suspension				
Description		Part #	Qty	Notes
Coil Spring		FORD 100	1 pair	Up to 50kg constant
		FORD 100HD	1 pair	55kg - 85kg constant
Shock Absorber		G38-5651	2	Gas charged strut
		BSBK-24	2	Bump stop kit
Strut Cap		10-1081	2	Replacement strut top cap
Strut Spacer		10-1091	2	6mm thick for trimming or raising vehicle
Upper Control Arms		UCAB02-01-0	1 pair	

Rear Suspension				
Description		Part #	Qty	Notes
Leaf Spring		FORD 106	1 pair	Constant 100kg
		FORD 106HD	1 pair	Constant 250kg
Shock Absorber		G36-5601	2	Gas charged









Make: FORD
Model: EVEREST UB 4WD 7/2022 on (REF FORD007K)

Front Suspension				
Description		Part #	Qty	Notes
Coil Spring		FORD 101L	1 pair	2lt Bi Turbo
		FORD 101	1 pair	2lt HD or V6
		FORD 101HD	1 pair	V6 HD
Shock Absorber		G38-5652	2	Gas charged strut
		BSBK-25	2	Bump stop kit
Strut Cap		10-1080	2	Replacement strut top cap
Strut Spacer		10-1091	2	6mm thick for trimming or raising vehicle
Upper Control Arms		UCAB02-04-0	1 pair	Steel knuckle
		UCAB02-05-0	1 pair	Aluminium knuckle



Rear Suspension				
Description		Part #	Qty	Notes
Leaf Spring		FORD 106	2	Constant 100kg
		FORD 106HD	2	Constant 250kg
Shock Absorber		G36-5601	2	Gas charged



Make: FORD
Model: F250 4WD and 2WD 2000 - 2006 (REF FORD001K)

Front Suspension				
Description		Part #	Qty	Notes
Leaf Spring		FORD 29P	2	3 leaf parabolic 50mm + (bushed)
Shock Absorber		G36-5600	2	Gas charged std - 60mm
Panhard Rod		10-1014	1	Adjustable panhard rod
U/Bolt		UB471	4	Square top U-bolt
Bush		3195	2	Fixed end
		3194	4	Shackle end upper and lower

Rear Suspension				
Description		Part #	Qty	Notes
Leaf Spring		FORD 33	2	6 (5+1) leaf 40mm + constant 300kg (bushed)
Shock Absorber		G36-5603	2/4	Gas charged
U/Bolt		UB472	4	Round top U-bolts
Bush		3195	2	Fixed end
		3194	4	Shackle end upper and lower

Make: FORD
Model: F150 2014 on (REF FORD005K)

Front Suspension				
Description		Part #	Qty	Notes
Coil Spring		Reuse OEM Coils	1 pair	
Monotube 2.0 Shock Absorber		MG-1608G50	2	Adjustable coil seat height for standard- 2" lift Reuse OE Cap & Dust Cover
Upper Control Arms		UCA02-03-0-FK	1 pair	

Rear Suspension				
Description		Part #	Qty	Notes
Leaf Spring		FORD 34	2	4 (3+1) leaf Constant 300kg (bushed)
Monotube 2.0 Shock Absorber		MG-1005P	2	Suits 0-2" Lift
U/Bolt		UB471HD	4	Square top U-bolt

Make: FORD
Model: F250 2014 on (REF FORD008K)

Front Suspension

Description		Part #	Qty	Notes
Coil Spring		Reuse OEM Coils	1 pair	
Monotube 2.0 Shock Absorber		MG-1607P	2	Suits 0-2" Lift

Rear Suspension







Description		Part #	Qty	Notes
Extra Leaf		EXL-F250	2	1.5" Lift
Monotube 2.0 Shock Absorber		MG-1013P	2	Suits 0-2" Lift
U/Bolt		UB450	4	Semi round Top U-bolt

Make: GREAT WALL MOTORS
Model: V240 UTE (REF H0L002K)

Front Suspension

Description		Part #	Qty	Notes
Torsion Bar		TB1550	1 pair	30mm Ø x 1142mm
Shock Absorber		G36-5604	2	Gas charged

Rear Suspension

Description		Part #	Qty	Notes
Leaf Spring		H0L 02	2	6 (4+2) leaf constant 300kg
		H0L 02HD	2	7 (5+2) leaf constant 400kg
Shock Absorber		G36-5562	2	Gas charged
Bush Kit		UK728	1	Urethane bush kit
Fixed Pin		SP385/1	2	14mm pin
Shackle		SK386G	2	Greasable shackle
		SK386EXG	2	Greasable shackle extended
U/Bolt		UB473	4	Round top U-bolt





Make: GREAT WALL MOTORS
Model: X240 WAGON (REF GWM001K)

Front Suspension

Description		Part #	Qty	Notes
Torsion Bar		TB1550	1 pair	30mm Ø x 1142mm
Shock Absorber		G36-5604	2	Gas charged

Rear Suspension







Description		Part #	Qty	Notes
Coil Spring		NIS 112	1 pair	Constant 150kg
Shock Absorber		G36-5563A	2	Gas charged

Make: GREAT WALL MOTORS
Model: CANNON (REF GWM002K)

Front Suspension

Description		Part #	Qty	Notes
Coil Spring		TPR 104HD	1 pair	To 50kg constant >40mm
		TPR 104HHD	1 pair	To 70kg constant >50mm
Shock Absorber		G38-5643	2	Gas charged strut
Strut Cap		10-1090	2	Replacement strut top cap



Rear Suspension

Description		Part #	Qty	Notes
Leaf Spring		GWM 02	2	6 (4+2) leaf constant 300kg
		GWM 02HD	2	7 (5+2) leaf constant 500kg
Shock Absorber		G36-5524	2	Gas charged
Bush Kit		UK771	1	Urethane bush kit
Fixed Pin		SP385/1	2	14mm pin
Shackle		SK389G	2	Greasable shackle
U/Bolt		UB473	4	Round top U-bolt

Make: GREAT WALL MOTORS
 Model: TANK 300 2020 on (REF GWM003K)





Front Suspension				
Description		Part #	Qty	Notes
Coil Spring		CGP00001	1 pair	Up to 50kg constant
Shock Absorber		SRA03K028	2	Adjustable Shock (Kalahari Series)
Strut Cap		10-1090	2	Replacement strut top cap







Rear Suspension				
Description		Part #	Qty	Notes
Coil Spring		CGP00002	1 pair	Up to 100kg constant
Shock Absorber		SRA02K084	2	Adjustable Shock (Kalahari Series)
Pan Hard Rod		PD00012	1	Adjustable

Make: HOLDEN
Model: RODEO KB to TF 1981 - 2002 (REF HOLO01K)

Front Suspension

Description		Part #	Qty	Notes
Torsion Bar		TB1546	1 pair	26mm Ø x 927mm—1983-7/1988 models
		TB1547	1 pair	26mm Ø x 1000mm—8/1988-2002 models
		TB1556	1 pair	27mm Ø x 1000mm—8/1988-2002 models
Shock Absorber		G36-5535	2	Gas charged

Rear Suspension

Description		Part #	Qty	Notes
Leaf Spring		HOL 01	2	7 (5+2) leaf constant 250kg
Shock Absorber		G36-5562	2	Gas charged
Bush Kit		UK728	1	8/1988 model on
Fixed Pin		SP385/1	2	Suits UK 728
Shackle		SK386G	2	Greasable shackle
		SK386EXG	2	Greasable shackle extended
U/Bolt		UB415	4	Round top U-bolt

Make: HOLDEN
Model: RODEO RA 2003 - 2008 (REF HOLO02K)

Front Suspension

Description		Part #	Qty	Notes
Torsion Bar		TB1550	1 pair	30mm Ø x 1142mm
Shock Absorber		G36-5604	2	Gas charged

Rear Suspension







Description		Part #	Qty	Notes
Leaf Spring		HOL 02	2	6 (4+2) leaf constant 300kg
		HOL 02HD	2	7 (5+2) leaf constant 400kg
Shock Absorber		G36-5562	2	Gas charged
Bush Kit		UK728	1	Urethane bush kit
Fixed Pin		SP385/1	2	14mm pin
Shackle		SK386G	2	Greasable shackle
		SK386EXG	2	Greasable shackle extended
U/Bolt		UB473	4	Round top U-bolt

Make: HOLDEN
Model: COLORADO RC 2008 - 05/2012 (REF HOL002K)

Front Suspension







Description		Part #	Qty	Notes
Torsion Bar		TB1550	1 pair	30mm Ø x 1142mm
Shock Absorber		G36-5604	2	Gas charged

Rear Suspension





Description		Part #	Qty	Notes
Leaf Spring		HOL 02	2	6 (4+2) leaf constant 300kg
		HOL 02HD	2	7 (5+2) leaf constant 400kg
Shock Absorber		G36-5562	2	Gas charged
Bush Kit		UK728	1	Urethane bush kit
Fixed Pin		SP385/1	2	14mm pin
Shackle		SK386G	2	Greasable shackle
		SK386EXG	2	Greasable shackle extended
U/Bolt		UB473	4	Round top U-bolt

Make: HOLDEN
Model: COLORADO RG 06/2012 - 2020 (REF HOL006K)

Front Suspension

Description		Part #	Qty	Notes
Coil Spring		TPR 104	1 pair	To 60kg constant
		TPR 104HD	1 pair	60kg - 90kg constant
Shock Absorber		G38-5660	2	Gas charged strut
Monotube Remote Reservoir Shock Absorber		MXA5-9602A50	2	High performance 46mm gas charged adjustable 8 stage
Strut Cap		10-1086	2	Replacement strut top cap
Strut Spacer		10-1091	2	6mm thick for trimming or raising vehicle
Upper Control Arms		UCAB06-01-0	1 pair	2012 - 2016 only

Rear Suspension

Description		Part #	Qty	Notes
Leaf Spring		HOL 03	2	6 (4+2) leaf constant 300kg
		HOL 03GVM	2	7 (5+2) leaf constant 500kg
Shock Absorber		G36-5562	2	Gas charged
Monotube Remote Reservoir Shock Absorber		MPA5-4052PL	1	Left side piggy back
		MPA5-4052PR	1	Right side piggy back
Bush Kit		UK867	1	Urethane bush kit
Fixed Pin		SP385/1	2	14mm pin
Shackle		SK390G	2	Greasable shackle
U/Bolt		UB437A	4	Square top U-bolt
Brake Hose Relocator		10-1099	1	



Make: HOLDEN

Model: COLORADO 7/TRAILBLAZER 2012 - 2020 (REF H0L007K)

Front Suspension

Description		Part #	Qty	Notes
Coil Spring		TPR 104	1 pair	Up to 60kg constant
		TPR 104HD	1 pair	Up to 90kg constant
Shock Absorber		G38-5660	2	Gas charged strut
Strut Cap		10-1086	2	Replacement strut top cap
Strut Spacer		10-1091	2	6mm thick for trimming or raising vehicle
Upper Control Arms		UCAB06-01-0	1 pair	



Rear Suspension

Description		Part #	Qty	Notes
Coil Spring		HOL 106	1 pair	Constant 100kg - 150kg
Shock Absorber		G36-5563B	2	Gas charged

Make: HOLDEN

Model: JACKAROO 5/1992 - 2004 (REF H0L003K)

Front Suspension

Description		Part #	Qty	Notes
Torsion Bar		TB1549	1 pair	29mm Ø x 1220mm - check OE length
Shock Absorber		G36-5604	2	Gas charged

Rear Suspension







Description		Part #	Qty	Notes
Coil Spring		HOL 101	1 pair	Constant 100kg
		HOL 101HD	1 pair	Constant 200kg
Shock Absorber		G36-5595	2	Gas charged

Make: ISUZU
Model: D-MAX RA-RC 2003 - 06/2012 (REF HOL002K)

Front Suspension







Description		Part #	Qty	Notes
Torsion Bar		TB1550	1 pair	30mm Ø x 1142mm
Shock Absorber		G36-5604	2	Gas charged

Rear Suspension

Description		Part #	Qty	Notes
Leaf Spring		HOL 02	2	6 (4+2) leaf constant 300kg
		HOL 02HD	2	7 (5+2) leaf constant 400kg
Shock Absorber		G36-5562	2	Gas charged
Bush Kit		UK728	1	Urethane bush kit
Fixed Pin		SP385/1	2	14mm pin
Shackle		SK386G	2	Greasable shackle
		SK386EXG	2	Greasable shackle extended
U/Bolt		UB473	4	Round top U-bolt

Make: ISUZU
Model: D-MAX RT 07/2012 - 08/2020 (REF ISU002K)





Front Suspension







Description		Part #	Qty	Notes
Coil Spring		TPR 104	1 pair	To 60kg constant
		TPR 104HD	1 pair	60kg - 90kg constant
Shock Absorber		G38-5660	2	Gas charged strut
Monotube Remote Reservoir Shock Absorber		MXA5-9602A50	2	High performance 46mm gas charged adjustable 8 stage
Strut Cap		10-1086	2	Replacement strut top cap
Strut Spacer		10-1091	2	6mm thick for trimming or raising vehicle
Upper Control Arms		UCAB06-01-0	1 pair	

Rear Suspension

Description		Part #	Qty	Notes
Leaf Spring		HOL 03	2	6 (4+2) leaf constant 300kg
		HOL 03GVM	2	7 (5+2) leaf constant 500kg
Shock Absorber		G36-5562	2	Gas charged
Monotube Remote Reservoir Shock Absorber		MPA5-4052PL	1	Left side piggy back
		MPA5-4052PR	1	Right side piggy back
Bush Kit		UK867	1	Urethane bush kit
Fixed Pin		SP385/1	2	14mm pin
Shackle		SK390G	2	Greasable shackle
U/Bolt		UB437A	4	Square top U-bolt
Brake Hose Relocator		10-1099	1	





Make: ISUZU
Model: D-MAX RG 09/2020 on (REF ISU004K)

Front Suspension				
Description		Part #	Qty	Notes
Coil Spring		TPR 104	1 pair	To 60kg constant
		TPR 104HD	1 pair	60kg - 90kg constant
Shock Absorber		G38-5661	2	Gas charged strut
Strut Cap		10-1086	2	Replacement strut top cap
Strut Spacer		10-1091	2	6mm thick for trimming or raising vehicle
Upper Control Arms		UCAB06-02-0	1 pair	

Rear Suspension				
Description		Part #	Qty	Notes
Leaf Spring		ISUZU 01	2	4 (3+1) leaf constant 250kg
		ISUZU 01HD	2	5 (4+1) leaf constant 350kg
Shock Absorber		G36-5562	2	Gas charged
Bush Kit		UK868	1	Urethane bush kit
Fixed Pin		SP385/1	2	14mm pin
Shackle		SK392G	2	Greasable shackle
U/Bolt		UB437B	4	Square top U-bolt

Make: ISUZU
Model: MU-X RF 2013 - 07/2021 (REF ISU003K)





Front Suspension



Description		Part #	Qty	Notes
Coil Spring		TPR 104	1 pair	Up to 60kg constant
		TPR 104HD	1 pair	Up to 90kg constant
Shock Absorber		G38-5660	2	Gas charged strut
Strut Cap		10-1086	2	Replacement strut top cap
Strut Spacer		10-1091	2	6mm thick for trimming or raising vehicle
Upper Control Arms		UCAB06-01-0	1 pair	

Rear Suspension



Description		Part #	Qty	Notes
Coil Spring		HOL 101	1 pair	Constant 100kg - 20mm - 30mm Lift
		HOL 101HD	1 pair	Constant 100kg - 50mm Lift
Shock Absorber		G36-5563B	2	Gas charged





Make: ISUZU
Model: MU-X RJ 09/2021 on (REF ISU005K)

Front Suspension				
Description		Part #	Qty	Notes
Coil Spring		TPR 104	1 pair	Up to 60kg constant
		TPR 104HD	1 pair	Up to 90kg constant
Shock Absorber		G38-5661	2	Gas charged strut
Strut Cap		10-1086	2	Replacement strut top cap
Strut Spacer		10-1091	2	6mm thick for trimming or raising vehicle
Upper Control Arms		UCAB06-02-0	1 pair	



Rear Suspension				
Description		Part #	Qty	Notes
Coil Spring		HOL 101	1 pair	Constant 100kg - 20mm - 30mm Lift
		HOL 101HD	1 pair	Constant 100kg - 50mm Lift
Shock Absorber		G36-5563B	2	Gas charged
Extended Swaybar Link Kit		10-1030	1	Multi fit



Make: JEEP
Model: CHEROKEE XJ SPORT - excl GRAND (REF JEEPO01K)

Front Suspension				
Description		Part #	Qty	Notes
Coil Spring		JEEP 100	1 pair	To 45kg constant
Shock Absorber		G36-3237	2	Gas charged strut



Rear Suspension				
Description		Part #	Qty	Notes
Leaf Spring		JEEP 02	2	5 leaf spring
Shock Absorber		G36-3236	2	Gas charged
Bush Kit		UK761	1	Urethane bush kit
U/Bolt		UB673	4	Round top U-bolt



Make: JEEP
Model: CHEROKEE KJ 09/2001 - 2007 (REF JEEPO04K)

Front Suspension				
Description		Part #	Qty	Notes
Coil Spring		JEEP 107	1 pair	To 45kg constant (petrol engine)
		JEEP 107HD	1 pair	To 45kg constant (diesel engine)
Shock Absorber		G38-5641	2	Gas charged strut
Strut Spacer		10-1091	2	6mm thick for trimming or raising vehicle



Rear Suspension				
Description		Part #	Qty	Notes
Coil Spring		JEEP 108	1 pair	100kg constant
Shock Absorber		G36-3294	2	Gas charged



Make: JEEP
Model: CHEROKEE KK 2009 - 2012 (REF JEEP008K)

Front Suspension				
Description		Part #	Qty	Notes
Coil Spring		JEEP 117	1 pair	To 45kg constant
Shock Absorber		G38-5641	2	Gas charged strut
Strut Spacer		10-1091	2	6mm thick for trimming or raising vehicle

Rear Suspension				
Description		Part #	Qty	Notes
Coil Spring		JEEP 118	1 pair	100kg constant
Shock Absorber		G36-3294	2	Gas charged



Make: JEEP
Model: WRANGLER TJ 1996 - 02/2007 (REF JEEP005K)



Front Suspension				
Description		Part #	Qty	Notes
Coil Spring		JEEP 101	1 pair	To 45kg constant (petrol engine)
Shock Absorber		G36-3204	2	Gas charged

Rear Suspension				
Description		Part #	Qty	Notes
Coil Spring		JEEP 104	1 pair	100kg constant
Shock Absorber		G36-3293	2	Gas charged







Make: JEEP
Model: WRANGLER JK 03/2007 - 2018 (REF JEEP006K)

Front Suspension				
Description		Part #	Qty	Notes
Coil Spring		JEEP 111	1 pair	To 45kg constant (petrol engine)
		JEEP 112	1 pair	To 45kg constant (diesel engine)
Shock Absorber		G36-3295	2	Gas charged
Pan Hard Rod		10-1065	1	Adjustable

Rear Suspension				
Description		Part #	Qty	Notes
Coil Spring		JEEP 113	1 pair	SWB 100kg constant
		JEEP 114	1 pair	LWB 100kg constant
Shock Absorber		G36-3296	2	Gas charged
Pan Hard Rod		10-1055	1	Adjustable



Make: JEEP
Model: GRAND CHEROKEE ZG-ZJ 1993 - 1998 (REF JEEP003K)



Front Suspension				
Description		Part #	Qty	Notes
Coil Spring		JEEP 100	1 pair	To 45kg constant
Shock Absorber		G36-3204	2	Gas charged

Rear Suspension				
Description		Part #	Qty	Notes
Coil Spring		JEEP 103	1 pair	100kg constant
Shock Absorber		G36-3207	2	Gas charged







Make: JEEP
Model: GRAND CHEROKEE WJ-WG 1999 - 2004 (REF JEEP002K)

Front Suspension				
Description		Part #	Qty	Notes
Coil Spring		JEEP 102	1 pair	To 45kg constant
Shock Absorber		G36-3204	2	Gas charged

Rear Suspension				
Description		Part #	Qty	Notes
Coil Spring		JEEP 106	1 pair	100kg constant
Shock Absorber		G36-3205	2	Gas charged

Make: JEEP
Model: GRAND CHEROKEE WH-WK1 07/2005 - 2010 (REF JEEP007K)



Front Suspension				
Description		Part #	Qty	Notes
Coil Spring		JEEP 115	1 pair	To 45kg constant
Shock Absorber		G38-5642	2	Gas charged strut

Rear Suspension				
Description		Part #	Qty	Notes
Coil Spring		JEEP 116	1 pair	100kg constant
Shock Absorber		G36-3297	2	Gas charged

Make: LAND ROVER



Model: DISCOVERY to 02/1999 - RANGE ROVER 1971 - 1998 EXCLUDES AIR SUSPENSION (REF LAN001K)

Front Suspension				
Description		Part #	Qty	Notes
Coil Spring		LAN 106	1 pair	To 45kg constant
Shock Absorber		G36-5592	2	Gas charged
Steering Damper		SD4011	1	Pin - pin

Rear Suspension				
Description		Part #	Qty	Notes
Coil Spring		LAN 112	1 pair	100kg constant (Range Rover)
		LAN 113	1 pair	100kg constant (Discovery)
		LAN 113HD	1 pair	250kg constant
Shock Absorber		G36-5593	2	Gas charged



Make: LAND ROVER



Model: DISCOVERY SERIES 2, TDS, 3/1999 - 2004 (REF LAN003K)

Front Suspension				
Description		Part #	Qty	Notes
Coil Spring		LAN 108	1 pair	To 45kg constant
Shock Absorber		G36-5598	2	Gas charged
Steering Damper		SD4012	1	Eye - eye



Rear Suspension				
Description		Part #	Qty	Notes
Coil Spring		LAN 113	1 pair	100kg constant
		LAN 113HD	1 pair	250kg constant
Shock Absorber		G36-5599	2	Gas charged



Make: LAND ROVER
Model: DEFENDER 110 (REF LAN002K)

Front Suspension				
Description		Part #	Qty	Notes
Coil Spring		LAN 107	1 pair	To 45kg constant
		LAN 107HD	1 pair	To 80kg constant
Shock Absorber		G36-5592	2	Gas charged

Rear Suspension				
Description		Part #	Qty	Notes
Coil Spring		LAN 102	1 pair	200kg constant
		LAN 102HD	1 pair	350kg constant
Shock Absorber		G36-5593	2	Gas charged





Make: LAND ROVER
Model: DEFENDER 130 (REF LAN004K)

Front Suspension				
Description		Part #	Qty	Notes
Coil Spring		LAN 107	1 pair	To 45kg constant
		LAN 107HD	1 pair	To 80kg constant
Shock Absorber		G36-5592	2	Gas charged

Rear Suspension				
Description		Part #	Qty	Notes
Coil Spring		LAN 102HD	1 pair	200kg constant
Shock Absorber		G36-5591	2	Gas charged

Make: LDV
Model: T60 2017 on (REF LDV001K)

Front Suspension







Description		Part #	Qty	Notes
Coil Spring		TPR 104	1 pair	To 60kg constant
		TPR 104HD	1 pair	60kg - 90kg constant
Shock Absorber		G38-5660	2	Gas charged strut
Monotube Remote Reservoir Shock Absorber		MXA5-9602A50	2	High performance 46mm gas charged adjustable 8 stage
Strut Cap		10-1086	2	Replacement strut top cap
Strut Spacer		10-1091	2	6mm thick for trimming or raising vehicle

Rear Suspension

Description		Part #	Qty	Notes
Leaf Spring		LDV 01	2	6 (4+2) leaf constant 300kg
		LDV 01HD	2	7 (5+2) leaf constant 500kg
Shock Absorber		G36-5562	2	Gas charged
Monotube Remote Reservoir Shock Absorber		MPA5-4052PL	1	Left side piggy back
		MPA5-4052PR	1	Right side piggy back
Bush Kit		UK867	1	Urethane bush kit
Fixed Pin		SP385/1	2	14mm pin
Shackle		SK390G	2	Greasable shackle
U/Bolt		UB437A	4	Square top U-bolt
Headlight Leveling Bracket		10-1097	1	Used to extend mount for headlight leveling arm on rear springs
Brake Hose Relocator		10-1099	1	

Make: LDV
Model: D90 (REF LDV002K)

Front Suspension

Description		Part #	Qty	Notes
Coil Spring		TPR 104	1 pair	To 60kg constant
		TPR 104HD	1 pair	60kg - 90kg constant
Shock Absorber		G38-5660	2	Gas charged strut
Monotube Remote Reservoir Shock Absorber		MXA5-9602A50	2	High performance 46mm gas charged adjustable 8 stage
Strut Cap		10-1086	2	Replacement strut top cap
Strut Spacer		10-1091	2	6mm thick for trimming or raising vehicle
Upper Control Arms		UCAB06-01-0	1 pair	

Rear Suspension







Description		Part #	Qty	Notes
Coil Spring		HOL 106	1 pair	Constant 100kg - 150kg
Shock Absorber		G36-5527	2	Gas charged
Monotube Remote Reservoir Shock Absorber		MPA5-5009PL	1	Left side piggy back
		MPA5-5009PR	1	Right side piggy back

Make: MAZDA
Model: B2600 1986 - 2006 (REF MAZD001K)

Front Suspension

Description		Part #	Qty	Notes
Torsion Bar		TB1546	1 pair	26mm Ø x 927mm
Shock Absorber		G36-5535	2	Gas charged

Rear Suspension

Description		Part #	Qty	Notes
Leaf Spring		MAZD 01	2	7 (5+2) leaf constant 250kg
		MAZD 01HD	2	8 (6+2) leaf constant 450kg
Shock Absorber		G36-5522	2	Gas charged
Bush Kit		UK756	1	Urethane bush kit
Fixed Pin		SP794G	2	Greasable pin
Shackle		SK386/1G	2	Greasable shackle
U/Bolt		UB415	4	Round top U-bolt







Make: MAZDA

Model: BT50 4WD UN 2006 - 10/2011 (REF MAZD002K)

Front Suspension

Description		Part #	Qty	Notes
Torsion Bar		TB1551	1 pair	27mm Ø x 1024mm
Shock Absorber		G36-5535	2	Gas charged







Rear Suspension

Description		Part #	Qty	Notes
Leaf Spring		MAZD 02	2	6 (4+2) leaf constant 300kg
		MAZD 02HD	2	7 (5+2) leaf constant 500kg
Shock Absorber		G36-5522	2	Gas charged
Bush Kit		UK769	1	Urethane bush kit
Fixed Pin		SP385/1	2	14mm pin
Shackle		SK386/1G	2	Greasable shackle
U/Bolt		UB473	4	Round top U-bolt

Make: MAZDA

Model: BT50 4WD - 2WD HI-RIDER UP/UR 10/2011 - 08/2020 (REF MAZD003K)





Front Suspension







Description		Part #	Qty	Notes
Coil Spring		MAZD 100SH	1 pair	To 70kg constant - std > 20mm
		MAZD 100	1 pair	To 70kg constant 50mm
		MAZD 100HD	1 pair	70kg - 120kg constant 50mm
Shock Absorber		G38-5650	2	Gas charged strut
Monotube Remote Reservoir Shock Absorber		MXA5-1603A50	2	High performance 46mm gas charged adjustable 8 stage
Strut Cap		10-1085	2	Replacement strut top cap
Strut Spacer		10-1091	2	6mm thick for trimming or raising vehicle
Upper Control Arms		UCAB02-01-0	1 pair	

Rear Suspension



Description		Part #	Qty	Notes
Leaf Spring		MAZD 03	2	6 (4+2) leaf constant 300kg
		MAZD 03GVM	2	7 (5+2) leaf constant 500kg
Shock Absorber		G36-5522	2	Gas charged
Monotube Remote Reservoir Shock Absorber		MPA5-4045PL	1	Left side piggy back
		MPA5-4045PR	1	Right side piggy back
Bush Kit		UK770	1	Urethane bush kit
Fixed Pin		SP385/1	2	14mm pin
Shackle		SK389G	2	Greasable shackle
U/Bolt		UB473	4	Round top U-bolt
Centre Bearing Spacer		CBS01	1	Helps reduce tail shaft vibration





Make: MAZDA
Model: BT50 4WD TF 09/2020 on (REF ISU004K)

Front Suspension				
Description		Part #	Qty	Notes
Coil Spring		TPR 104	1 pair	To 60kg constant
		TPR 104HD	1 pair	To 60kg - 90kg constant
Shock Absorber		G38-5661	2	Gas charged strut
Strut Cap		10-1086	2	Replacement strut top cap
Strut Spacer		10-1091	2	6mm thick for trimming or raising vehicle
Upper Control Arms		UCAB06-02-0	1 pair	

Rear Suspension				
Description		Part #	Qty	Notes
Leaf Spring		ISUZU 01	2	4 (3+1) leaf constant 250kg
		ISUZU 01HD	2	5 (4+1) leaf constant 350kg
Shock Absorber		G36-5562	2	Gas charged
Bush Kit		UK868	1	Urethane bush kit
Fixed Pin		SP385/1	2	14mm pin
Shackle		SK392G	2	Greasable shackle
U/Bolt		UB437B	4	Square top U-bolt



Make: MITSUBISHI
Model: PAJERO SWB and LWB 1983 - 1996 (REF MITS0075K-LK)



Front Suspension				
Description		Part #	Qty	Notes
Torsion Bar Note: Check torsion bar dimensions		TB200	1 pair	26mm Ø x 1280mm - NA, NB, NC, ND, NE, NG
		TB203	1 pair	27.5mm Ø x 1307mm, 6CYL and TDI - NH, NJ
Shock Absorber		G36-5530	2	To 04/1991 gas charged
		G36-5535	2	04/1991 ON gas charged

Rear Suspension				
Description		Part #	Qty	Notes
Leaf Spring		MITS 30	2	5 (4+1) leaf 150kg to GVM, NH-NJ, SWB NA-NG
		MITS 31	2	5 (4+1) leaf 150kg to GVM, LWB NA-NG
Shock Absorber		G36-5562	2	Gas charged
Bush Kit		UK715	1	Urethane bush kit
Shackle		SK795G	2	Greasable shackle
U/Bolt		UB451	4	Round top U-bolt

Make: MITSUBISHI





Model: PAJERO SWB and LWB 1988 - 2000 (REF MIT5006SK-LK)



Front Suspension				
Description		Part #	Qty	Notes
Torsion Bar Note: Check torsion bar dimensions		TB200	1 pair	26mm Ø x 1280mm - NF, NG
		TB203	1 pair	27.5mm Ø x 1307mm, NH, NL
Shock Absorber		G36-5530	2	To 04/1991 gas charged
		G36-5535	2	05/1991 ON gas charged

Rear Suspension				
Description		Part #	Qty	Notes
Coil Spring		MIT 102	1 pair	SWB constant 100kg
		MIT 101	1 pair	LWB constant 100kg
		MIT 101HD	1 pair	LWB constant 200kg
Shock Absorber	 	G36-5597	2	To 04/1991 gas charged
		G36-5580	2	05/1991 on gas charged

Make: MITSUBISHI

Model: PAJERO NM, NP, NS, NT, NW, NX 2000 on (REF MIT5005SK-LK)





Front Suspension				
Description		Part #	Qty	Notes
Coil Spring		MIT 100	1 pair	Petrol engine
		MIT 100HD	1 pair	Petrol HD or diesel engines
		MIT 100EHD	1 pair	Diesel HD engine
Shock Absorber		G38-5624	2	Gas charged strut
Strut Cap		10-1088	2	Replacement strut top cap
Strut Spacer		10-1091	2	6mm thick for trimming or raising vehicle

Rear Suspension				
Description		Part #	Qty	Notes
Coil Spring		MIT 103	1 pair	LWB constant 150kg
		MIT 103HD	1 pair	LWB constant 300kg
		MIT 106	1 pair	SWB constant 150kg
Coil Spacer		10-1024	2	20mm spacer for raising or trimming vehicle
Shock Absorber		G36-5582	2	Gas charged

Make: MITSUBISHI

Model: PAJERO SPORT QE 10/2015 - 06/2019 / PAJERO SPORT QF 07/2019 on (REF MIT5002K)

Front Suspension

Description		Part #	Qty	Notes
Coil Spring		MIT 109	1 pair	To 60kg constant
		MIT 109H	1 pair	60kg - 90kg constant
Shock Absorber		G38-5639L	1	Gas charged strut LHS
		G38-5639R	1	Gas charged strut RHS
Strut Cap		10-1087	2	Replacement strut top cap
Strut Spacer		10-1091	2	6mm thick for trimming or raising vehicle
Upper Control Arms		UCAB05-01-1T	1 pair	



Rear Suspension

Description		Part #	Qty	Notes
Coil Spring		MIT 102	1 pair	Constant 100kg
		MIT 101	1 pair	Constant 200kg
Shock Absorber		G36-5597	2	Gas charged





Make: MITSUBISHI

Model: TRITON 4WD ME, MF, MG, MH, MJ, MK (REF MIT5003K)

Front Suspension

Description		Part #	Qty	Notes
Torsion Bar Note: Check torsion bar dimensions		TB200	1 pair	26mm Ø x 1280mm, ME-MH 1985-1992
		TB202	1 pair	26mm Ø x 1370mm, MJ 1993-1997
		TB204	1 pair	27.5 mm Ø x 1370 mm, MK 1997 on
Shock Absorber		G36-5530	2	To 11/1996 ME, MH, MJ Gas charged
		G36-5535	2	11/1996 on MK Gas charged
Steering Damper		SD4022	2	Steering damper 10/1987 - 5/1992, eye/pin - eye







Rear Suspension

Description		Part #	Qty	Notes
Leaf Spring		MITS 32	2	5 (4+1) leaf constant 250kg
Shock Absorber		G36-5523	2	Gas charged—use washer to space out top mount
Bush Kit		UK701	1	Urethane bush kit
Shackle		SK795G	2	Greasable shackle
U/Bolt		UB451	4	Round top U-bolt







Make: MITSUBISHI

Model: TRITON 4WD ML-MN (REF MITS004K)

Front Suspension

Description		Part #	Qty	Notes
Coil Spring		MIT 109	1 pair	To 70kg constant
		MIT 109H	1 pair	To 70kg - 100kg constant
Shock Absorber		G38-5639L	1	Gas charged strut LHS
		G38-5639R	1	Gas charged strut RHS
Monotube Remote Reservoir Shock Absorber		MXA5-4686A50	2	High performance 46mm gas charged adjustable 8 stage
Strut Cap		10-1087	2	Replacement strut top cap
Strut Spacer		10-1091	2	6mm thick for trimming or raising vehicle
Upper Control Arms		UCAB05-01-0	1 pair	

Rear Suspension

Description		Part #	Qty	Notes
Leaf Spring		MITS 33	2	7 (5+2) leaf constant 300kg
		MITS 33HD	2	8 (6+2) leaf constant 450kg
Shock Absorber		G36-5559	2	Gas charged
Monotube Remote Reservoir Shock Absorber		MXA5-4012P	2	High performance 46mm gas charged adjustable 8 stage
Bush Kit		UK762	1	Urethane bush kit
Shackle		SK795G	2	Greasable shackle
U/Bolt		UB474	4	12mm Ø square top U-bolt, ML & MN to 03/2013
		UB464	4	14mm Ø square top U-bolt, MN 04/2013 on, check diameter
Tail Shaft Spacer		TSS 01	1	Suits 2 piece tail shaft







Please Note:

ML/MN Tritons with the "easy select" transmission (Identifiable by a two-piece tail shaft) are renowned for developing a driveline vibration on take-off. This vibration is caused by a combination of the short tail shaft length and the difference in angles between the universal joints and centre bearing. Fitting a 22mm tail shaft spacer on the diff side of the tail shaft reduces the severity of this vibration. It doesn't always eliminate the vibration completely but does help reduce it and takes pressure off the centre bearing.

Vehicles with the "Super Select Manual" or Automatic transmissions do not suffer from the same vibration. These vehicles have a one-piece tail shaft from factory.

Make: MITSUBISHI
Model: TRITON 4WD MQ-MR (REF MIT500BK)

Front Suspension

Description		Part #	Qty	Notes
Coil Spring		MIT 109H	1 pair	To 70 kg constant
		MIT 109HD	1 pair	To 70kg - 100kg constant
Shock Absorber		G38-5639L	1	Gas charged strut LHS
		G38-5639R	1	Gas charged strut RHS
Monotube Remote Reservoir Shock Absorber		MXA5-4686A50	2	High performance 46mm gas charged adjustable 8 stage
Strut Cap		10-1087	2	Replacement strut top cap
Strut Spacer		10-1091	2	6mm thick for trimming or raising vehicle
Upper Control Arms		UCAB05-01-1T	1 pair	

Rear Suspension

Description		Part #	Qty	Notes
Leaf Spring		MIT5 34	2	7 (5+2) leaf constant 250kg
		MIT5 34HD	2	8 (6+2) leaf constant 400kg
Shock Absorber		G36-5559	2	Gas charged
Monotube Remote Reservoir Shock Absorber		MXA5-4012P	2	High performance 46mm gas charged adjustable 8 stage
Bush Kit		UK763	1	Urethane bush kit
Shackle		SK796G	2	Greasable shackle
U/Bolt		UB437A	4	14mm Ø square top U-bolt
		UB437	4	Use with MIT5 34HD
Tail Shaft Spacer		TSS 01	1	
ABS Line Spacer Kit		B-002	1	
Brake Hose Relocator		10-1098	1	
Centre Bearing Strengthenener Kit		CBS04	1	

Make: MITSUBISHI
Model: TRITON 4WD MV (REF MIT5009K)



Front Suspension				
Description		Part #	Qty	Notes
Coil Spring		MIT 109H	1 pair	To 70 kg constant
		MIT 109HD	1 pair	To 70kg - 100kg constant
Shock Absorber		G38-5620	1	Gas charged strut
Monotube Shock Absorber		MX3-7611A50	2	High performance 46mm gas charged
Strut Cap		COMING SOON	2	Replacement strut top cap
Strut Spacer		10-1091	2	6mm thick for trimming or raising vehicle
Upper Control Arms		COMING SOON	1 pair	

Rear Suspension				
Description		Part #	Qty	Notes
Leaf Spring		MIT5 35	2	7 (5+2) leaf constant 250kg
		MIT5 35HD	2	8 (6+2) leaf constant 400kg
Shock Absorber		G36-5568	2	Gas charged
Monotube Shock Absorber		MX3-7011P	2	High performance 46mm gas charged
Bush Kit		UK763	1	Urethane bush kit
Fixed Pin		SP385/1	2	14 mm pin
Shackle		SK797G	2	Greasable shackle
U/Bolt		UB437A	4	14mm Ø square top U-bolt
		UB437	4	Use with MIT5 35HD

Make: MITSUBISHI





Model: CHALLENGER PA SERIES II, 8/2000 - 03/2007 (REF MIT5001K)

Front Suspension				
Description		Part #	Qty	Notes
Torsion Bar		TB 203	1 pair	27.5mm Ø x 1307mm
Shock Absorber		G36-5535	2	Gas charged

Rear Suspension				
Description		Part #	Qty	Notes
Coil Spring		MIT 102	1 pair	Constant 100kg
		MIT 101	1 pair	Constant 200kg
Shock Absorber		G36-5597	2	Gas charged

Make: MITSUBISHI

Model: CHALLENGER PB, PC 2010 - 2015 (REF MIT5002K)





Front Suspension				
Description		Part #	Qty	Notes
Coil Spring		MIT 109	1 pair	60kg constant
		MIT 109H	1 pair	60kg - 90kg constant
Shock Absorber		G38-5639L	1	Gas charged strut LHS
		G38-5639R	1	Gas charged strut RHS
Strut Cap		10-1087	2	Replacement strut top cap
Strut Spacer		10-1091	2	6mm thick for trimming or raising vehicle
Upper Control Arms		UCAB05-01-1T	1 pair	

Rear Suspension				
Description		Part #	Qty	Notes
Coil Spring		MIT 102	1 pair	Constant 100kg
		MIT 101	1 pair	Constant 200kg
Shock Absorber		G36-5597	2	Gas charged







Make: NISSAN

Model: PATROL GQ CAB CHASSIS - LEAF SPRING FRONT and REAR (REF NIS004K)







Front Suspension





Description		Part #	Qty	Notes
Leaf Spring		NIS 11	2	Suitable for bar and winch
Shock Absorber		G36-5563	2	Gas charged
Steering Damper		SD4022	2	Eye/pin - eye
Bush Kit		UK718	1	Urethane bush kit
Fixed Pin		SP667G	2	14mm pin
Shackle		SK353G	2	Greasable shackle
U/Bolt		UB668	4	Square top U-bolt

Rear Suspension

Description		Part #	Qty	Notes
Leaf Spring		NIS 12D/S	1	9 (7+2) leaf driver's side constant 250kg
		NIS 12N/S	1	9 (7+2) leaf near side constant 250kg
		NIS 12P D/S	1	3 (2+1) leaf driver's side parabolic option
		NIS 12P N/S	1	3 (2+1) leaf near side parabolic option
		NIS 15	1	9 (7+2) leaf constant 500kg
Shock Absorber		G36-5526	2	Gas charged
Bush Kit		UK719	1	Urethane bush kit
Fixed Pin		SP667G	2	14mm pin
Shackle		SK353RHG	1	Greasable anti inversion shackle
		SK353LHG	1	Greasable anti inversion shackle
U/Bolt		UB670	4	Round top U-bolt

Make: NISSAN
Model: PATROL GQ/Y60 LWB WAGON (REF NIS003K)







Front Suspension				
Description		Part #	Qty	Notes
Coil Spring		NIS 101	1 pair	To 45kg constant
		NIS 101HD	1 pair	To 100kg constant
Coil Spacer		10-1020	2	15mm spacer for raising or trimming vehicle
		10-1019	2	30mm spacer for raising or trimming vehicle
Shock Absorber		G36-5546	2	Gas charged
		G2491L	2	H/duty hydraulic
Monotube Remote Reservoir Shock Absorber		MXA5-5601P	2	High performance 46mm gas charged adjustable 8 stage
Steering Damper		SD4034	1	To 08/1989, eye - eye
		SD4036	1	8/1989 on, pin - pin
Castor Bush Kit		10-1004	1	Castor correction kit
Radius Arm Bush		10-1044	1	Radius arm to chassis mount

Rear Suspension				
Description		Part #	Qty	Notes
Coil Spring		NIS 114	1 pair	100kg constant
		NIS 109	1 pair	150kg constant progressive rated coil
		NIS 111SP	1 pair	300kg constant progressive rated coil
		NIS 114HD	1 pair	250kg - 300kg constant
Coil Spacer		10-1021	2	15mm spacer for raising or trimming vehicle
		10-1022	2	30mm spacer for raising or trimming vehicle
Shock Absorber		G36-5548	2	Gas charged
		G2492L	2	H/duty hydraulic
Monotube Remote Reservoir Shock Absorber		MXA5-5001P	2	High performance 46mm gas charged adjustable 8 stage
Trailing Arm Bushes		10-1045	4	1 kit per arm, same upper and lower





Make: NISSAN

Model: PATROL GQ-Y60/GU - Y61 LWB CAB CHASSIS (REF NIS009K)

Front Suspension

Description		Part #	Qty	Notes
Coil Spring		NIS 101	1 pair	To 45kg constant
		NIS 101HD	1 pair	To 100kg constant
Coil Spacer		10-1020	2	15mm spacer for raising or trimming vehicle
		10-1019	2	30mm spacer for raising or trimming vehicle
Shock Absorber		G36-5546	2	Gas charged
		G2491L	2	H/duty hydraulic
Monotube Remote Reservoir Shock Absorber		MXA5-5601P	2	High performance 46 mm gas charged adjustable 8 stage
Steering Damper		SD4011	1	Y61 GU, pin - pin
		SD4036	1	Y60 GQ, pin - pin
Castor Bush Kit		10-1004	1	Castor correction kit
Radius Arm Bush		10-1044	1	Radius arm to chassis mount







Rear Suspension

Description		Part #	Qty	Notes
Coil Spring		NIS 114	1 pair	100kg constant
		NIS 109	1 pair	150kg constant progressive rated coil
		NIS 114HD	1 pair	250kg - 300kg constant
		NIS 111	1 pair	300kg constant progressive rated coil
Coil Spacer		10-1021	2	15mm spacer for raising or trimming vehicle
		10-1022	2	30mm spacer for raising or trimming vehicle
Shock Absorber		G36-5548	2	Gas charged
		G2492L	2	H/duty hydraulic
Monotube Remote Reservoir Shock Absorber		MXA5-5001P	2	High performance 46mm gas charged adjustable 8 stage
Trailing Arm Bushes		10-1045	4	1 kit per arm, same upper and lower





Make: NISSAN

Model: PATROL GU/Y61 LWB WAGON (REF NIS0010K)

Front Suspension

Description		Part #	Qty	Notes
Coil Spring		NIS 101	1 pair	To 45kg constant
		NIS 101HD	1 pair	To 100kg constant
Coil Spacer		10-1020	2	15mm spacer for raising or trimming vehicle
		10-1019	2	30mm spacer for raising or trimming vehicle
Shock Absorber		G36-5546	2	Gas charged
		G2491L	2	H/duty hydraulic
Monotube Remote Reservoir Shock Absorber		MXA5-5601P	2	High performance 46mm gas charged adjustable 8 stage
Steering Damper		SD4011	1	To 01/2000, pin - pin
		SD4501	1	02/2000 on, eye/pin - eye/pin
Castor Bush Kit		10-1004	1	Castor correction kit
Radius Arm Bush		10-1044	1	Radius arm to chassis mount









Rear Suspension

Description		Part #	Qty	Notes
Coil Spring		NIS 109	1 pair	100kg constant progressive rated coil
		NIS 114HD	1 pair	200kg constant
		NIS 111SP	1 pair	250kg constant progressive rated coil
Coil Spacer		10-1021	2	15mm spacer for raising or trimming vehicle
		10-1022	2	30mm spacer for raising or trimming vehicle
Shock Absorber		G36-5548	2	Gas charged
		G2492L	2	H/duty hydraulic
Monotube Remote Reservoir Shock Absorber		MXA5-5001P	2	High performance 46mm gas charged adjustable 8 stage
Trailing Arm Bushes		10-1045	4	1 kit per arm, same upper and lower







Make: NISSAN

Model: PATROL GQ-Y60/GU-Y61 LWB 3-4" LIFT (REF NIS0011K)

Front Suspension

Description		Part #	Qty	Notes
Coil Spring		NIS 101HL3	1 pair	To 50kg constant
Coil Spacer		10-1020	2	15mm spacer for raising or trimming vehicle
		10-1019	2	30mm spacer for raising or trimming vehicle
Shock Absorber		G40-5546	2	Gas charged
Steering Damper		SD4034	1	GQ 88 to 08/1989, eye - eye
		SD4036	1	GQ 09/1989 on, pin - pin
		SD4011	1	GU to 01/2000, pin - pin
		SD4501	1	GU 02/2000 on, eye/pin - eye/pin
Castor Bush Kit		10-1040	1	Castor correction kit
Panhard Rod (adj)		10-1048	1	All models to 04/2000
		10-1050	1	GU series 2 - 04/2000 on (large spherical bush one end)
Extended Brake Hose		10-1038	1	Non ABS and single brake hose
Radius Arm Bush		10-1044	1	Radius arm to chassis mount







Rear Suspension

Description		Part #	Qty	Notes
Coil Spring		NIS 114HL3	1 pair	150kg constant
Coil Spacer		10-1021	2	15mm spacer for raising or trimming vehicle
		10-1022	2	30mm spacer for raising or trimming vehicle
Shock Absorber		G40-5548	2	Big bore shock
Panhard Rod (adj)		10-1049	1	All models to 04/2000
		10-1051	1	GU series 2 - 04/2000 on (large spherical bush one end)
Extended Brake Hose		10-1039	1	Non ABS and single brake hose
Trailing Arm Bushes		10-1045	4	1 kit per arm, same upper and lower







Make: NISSAN

Model: PATROL GU CAB CHASSIS - LEAF SPRING REAR (REF NIS008K)

Front Suspension

Description		Part #	Qty	Notes
Coil Spring		NIS 101	1 pair	To 45kg constant
		NIS 101HD	1 pair	To 100kg constant
Coil Spacer		10-1020	2	15mm spacer for raising or trimming vehicle
		10-1019	2	30mm spacer for raising or trimming vehicle
Shock Absorber		G36-5546	2	Gas charged
		G2491L	2	H/duty hydraulic
Steering Damper		SD4011	1	Pin - pin
Castor Bush Kit		10-1004	1	Castor correction kit
Radius Arm Bush		10-1044	1	Radius arm to chassis mount



Rear Suspension

Description		Part #	Qty	Notes
Leaf Spring		NIS 12D/S	1	9 (7+2) leaf driver's side constant 250kg
		NIS 12N/S	1	9 (7+2) leaf near side constant 250kg
		NIS 12P D/S	1	3 (2+1) leaf driver's side parabolic option
		NIS 12P N/S	1	3 (2+1) leaf near side parabolic option
		NIS 15	1	9 (7+2) leaf constant 500kg
Shock Absorber		G36-5526	2	Gas charged
Bush Kit		UK719	1	Urethane bush kit
Fixed Pin		SP667G	2	Greasable pin
Shackle		SK353RHG	1	Greasable anti inversion shackle
		SK353LHG	1	Greasable anti inversion shackle
U/Bolt		UB671	4	Round top U-bolt







Make: NISSAN

Model: NAVARA D21, 01/1986-02/1997 - D22, 02/1997-02/2015 (REF NIS002K)

Front Suspension

Description		Part #	Qty	Notes
Torsion Bar		TB1456	1 pair	D21-26mm Ø x 1202mm
		TB1446	1 pair	D22-26mm Ø x 890mm
Shock Absorber		G36-5535	2	D21 gas charged
		G36-3253	2	D22 gas charged







Rear Suspension

Description		Part #	Qty	Notes
Leaf Spring		NIS 13	2	5 (3+2) leaf constant 150kg
Shock Absorber		G36-5562	2	Gas charged
Bush Kit		UK704	1	Urethane bush kit
Fixed Pin		SP798G	2	Greasable pin
Shackle		SK669G	2	Greasable shackle
U/Bolt		UB660	4	Square top U-bolt

Make: NISSAN

Model: NAVARA D40 4WD, 2006 - 2015 (REF NIS007K)

Front Suspension

Description		Part #	Qty	Notes
Coil Spring		NIS 126	1 pair	To 40kg constant
		NIS 126HD	1 pair	To 70kg constant
		NIS 126HHD	1 pair	3L diesel
Shock Absorber		G38-5640	2	Gas charged strut
Monotube Remote Reservoir Shock Absorber		MXA5-56110A50	2	High performance 46mm gas charged adjustable 8 stage
Strut Cap		10-1089	2	Replacement strut top cap
Strut Spacer		10-1091	2	6mm thick for trimming or raising vehicle
Upper Control Arms		UCAB04-01-0	1 pair	







Rear Suspension

Description		Part #	Qty	Notes
Leaf Spring		NIS 14	2	6 (4+2) leaf constant 300kg
		NIS 14HD	2	7 (5+2) leaf constant 500kg
Shock Absorber		G36-5529	2	Gas charged
Monotube Remote Reservoir Shock Absorber		MPA5-5009PL	1	Left side piggy back
		MPA5-5009PR	1	Right side piggy back
Bush Kit		UK767	1	Urethane bush kit
Fixed Pin		SP385/1	2	14 mm pin
Shackle		SK388G	2	Greasable shackle
U/Bolt		UB437B	4	Square top U-bolt - use with NIS 14
		UB437A	4	Square top U-bolt - use with NIS 14HD





Make: NISSAN

Model: NAVARA D23 DUAL CAB, 2015 on (REF NIS0012K)

Front Suspension

Description		Part #	Qty	Notes
Coil Spring		NIS 126HD	1 pair	To 40kg constant
		NIS 126HHD	1 pair	To 70kg constant
Shock Absorber		G38-5640	2	Gas charged strut
Monotube Remote Reservoir Shock Absorber		MXA5-56110A50	2	High performance 46mm gas charged adjustable 8 stage
Strut Cap		10-1089	2	Replacement strut top cap
Strut Spacer		10-1091	2	6mm thick for trimming or raising vehicle
Upper Control Arms		UCAB04-01-0	1 pair	







Rear Suspension

Description		Part #	Qty	Notes
Coil Spring		NIS 130	1 pair	150kg constant progressive rated coil
		NIS 130HD	1 pair	250kg constant progressive rated coil
Shock Absorber		G36-5527	2	Gas charged
Monotube Remote Reservoir Shock Absorber		MPA5-5009PL	1	Left side piggy back
		MPA5-5009PR	1	Right side piggy back
Pan Hard Rod		10-1096	1	Must be installed for lifted springs
Extended Sway Bar Link Kit		10-1030	1	Multi fit







Make: NISSAN

Model: NAVARA D23 SINGLE CAB, 2015 on (REF NIS0013K)

Front Suspension

Description		Part #	Qty	Notes
Coil Spring		NIS 126HD	1 pair	To 40kg constant
		NIS 126HHD	1 pair	To 70kg constant
Shock Absorber		G38-5640	2	Gas charged strut
Monotube Remote Reservoir Shock Absorber		MXA5-56110A50	2	High performance 46mm gas charged adjustable 8 stage
Strut Cap		10-1089	2	Replacement strut top cap
Strut Spacer		10-1091	2	6mm thick for trimming or raising vehicle
Upper Control Arms		UCAB04-01-0	1 pair	

Rear Suspension

Description		Part #	Qty	Notes
Leaf Spring		NIS 16	2	6 (4+2) leaf constant 300kg
Shock Absorber		G36-5562	2	Gas charged
Monotube Remote Reservoir Shock Absorber		MPA5-4052PL	1	Left side piggy back
		MPA5-4052PR	1	Right side piggy back
Bush Kit		UK705	1	Urethane bush kit
Fixed Pin		SP385/1	2	14mm pin
Shackle		SK395G	2	Greasable shackle
U/Bolt		UB415	4	Round top U-bolt

Make: NISSAN



Model: PATHFINDER WD21, 1987 - 1995, R20 TERRANO 1997 - 1999 (REF NIS006K)



Front Suspension				
Description		Part #	Qty	Notes
Torsion Bar		TB 1458	1 pair	26mm Ø x 1230mm
Shock Absorber		G36-5535	2	Gas charged
Steering Damper		SD4035	1	Eye - eye

Rear Suspension				
Description		Part #	Qty	Notes
Coil Spring		NIS 112	1 pair	150kg constant
Shock Absorber		G36-5562	2	Gas charged

Make: NISSAN

Model: PATHFINDER R50, 11/1995 - 6/2005 (REF NIS005K)





Front Suspension				
Description		Part #	Qty	Notes
Coil Spring		NIS 102	1 pair	To 45kg constant
Shock Absorber		G38-5644	1	RHS strut, 11/1995 - 01/1999
		G38-5644/1	1	RHS strut, 02/1999 - 10/2001
		G38-5644/2	1	RHS strut, 11/2001 - 06/2005
		G38-5645	1	LHS strut, 11/1995 - 01/1999
		G38-5645/1	1	LHS strut, 02/1999 - 10/2001
		G38-5645/2	1	LHS strut, 11/2001 - 06/2005

Rear Suspension				
Description		Part #	Qty	Notes
Coil Spring		NIS 116	1 pair	100kg constant
Shock Absorber		G36-5557	2	11/1995 - 01/1999 gas charged
		G36-5558	2	02/1999 - 05/2005 gas charged



Make: NISSAN

Model: PATHFINDER R51, 7/2005 - 6/2013 (REF NISO05K-R51)

Front Suspension

Description		Part #	Qty	Notes
Coil Spring		NIS 126	1 pair	To 45kg constant
		NIS 126HD	1 pair	45kg - 70kg constant
Shock Absorber		G38-5640	2	Gas charged strut
Strut Cap		10-1089	2	Replacement strut top cap
Strut Spacer		10-1091	2	6mm thick for trimming or raising vehicle
Upper Control Arms		UCAB04-01-0	1 pair	

Rear Suspension







Description		Part #	Qty	Notes
Coil Spring		NIS 127	1 pair	150kg constant
Shock Absorber		G36-5528	2	Gas charged









Make: SUZUKI

Model: SIERRA SJ/LJ, WAGON and TRAYBACK (REF SUZ001K)

Front Suspension



Description		Part #	Qty	Notes
Leaf Spring		SUZI 01	2	4 leaf 50kg constant (trayback)
		SUZI 03	2	4 leaf 40kg constant (wagon)
Shock Absorber		G36-5483	2	Gas charged
Steering Damper		SD4030	2	Eye - eye
Bush Kit		UK734	1	Urethane bush kit
Fixed Pin		SP657	2	Shackle bolt
Shackle		SK656	2	Shackle kit
U/Bolt		UB654	2	Driver's side Round top U-bolt
		UB655	2	Near side Round top

Rear Suspension

Description		Part #	Qty	Notes
Leaf Spring		SUZI 02	1	5 (3+2) leaf constant 100kg (trayback)
		SUZI 05	1	5 (4+1) leaf constant 80kg (wagon)
Shock Absorber		G36-5487	2	Gas charged
Bush Kit		UK734	1	Urethane bush kit
Fixed Pin		SP657	2	Shackle bolt
Shackle		SK656	1	Shackle kit
U/Bolt		UB655	4	Round top U-bolt

Make: SUZUKI



Model: GRAND VITARA 4CYL SWB and LWB 04/1998 - 2001 (REF SUZ002K)

Front Suspension				
Description		Part #	Qty	Notes
Coil Spring		SUZ 114	1 pair	25mm lift
Shock Absorber		G38-5628	1	Gas charged strut (RHS)
		G38-5629	1	Gas charged strut (LHS)
Strut Spacer		10-1091	2	6mm thick for trimming or raising vehicle

Rear Suspension				
Description		Part #	Qty	Notes
Coil Spring		SUZ 111	1 pair	25mm lift
Shock Absorber		G36-5488	2	Gas charged

Make: SUZUKI



Model: GRAND VITARA V6CYL LWB 04/1998 - 2001 (REF SUZ003K)



Front Suspension				
Description		Part #	Qty	Notes
Coil Spring		SUZ 105	1 pair	25mm lift
Shock Absorber		G38-5628	1	Gas charged strut (RHS)
		G38-5629	1	Gas charged strut (LHS)
Strut Spacer		10-1091	2	6mm thick for trimming or raising vehicle

Rear Suspension				
Description		Part #	Qty	Notes
Coil Spring		SUZ 111	1 pair	25mm lift
Shock Absorber		G36-5488	2	Gas charged

Make: SUZUKI



Model: GRAND VITARA JB627 LWB 08/2005 - 07/2008 (REF SUZ004K)



Front Suspension				
Description		Part #	Qty	Notes
Coil Spring		SUZ 115	1 pair	Approx 30mm lift - to 40kg
Shock Absorber		G38-5646	1	Gas charged strut (RHS)
		G38-5647	1	Gas charged strut (LHS)
Strut Spacer		10-1091	2	6mm thick for trimming or raising vehicle

Rear Suspension				
Description		Part #	Qty	Notes
Coil Spring		SUZ 116	1 pair	Approx 30mm lift - to 80kg
Shock Absorber		G36-5491	2	Gas charged

Make: SUZUKI

Model: JIMNY SN413 1998 - 2016 (REF SUZ005K)



Front Suspension				
Description		Part #	Qty	Notes
Coil Spring		SUZ 106	1 pair	Approx 30mm lift - to 40kg
Shock Absorber		G36-5481	2	Gas charged





Rear Suspension				
Description		Part #	Qty	Notes
Coil Spring		SUZ 112	1 pair	Approx 30mm lift - to 80kg
Shock Absorber		G36-5482	2	Gas charged

Make: SUZUKI

Model: JIMNY A6G415 11/2018 on (REF SUZ008K)







Front Suspension				
Description		Part #	Qty	Notes
Coil Spring		CGL00019	1 pair	Up to 45kg constant
Shock Absorber		SRA02K078	2	Adjustable Shock (Kalahari Series)
Castor Bush Kit		CT00003	1	Castor correction kit

Rear Suspension				
Description		Part #	Qty	Notes
Coil Spring		CGL00017A	1 pair	Up to 80kg constant
Shock Absorber		SRA02K079	2	Adjustable Shock (Kalahari Series)
Brake Line Extension & Shock Mount Kit		RT00006	1	Required when lifting vehicle
Headlight Extension Bracket		RT00005	1	Corrects headlight alignment for lifted vehicles

Make: SUZUKI



Model: VITARA 2 DOOR 1.6L and 2L SWB 1988 - 03/1998 (REF SUZ006K)



Front Suspension				
Description		Part #	Qty	Notes
Coil Spring		SUZ 101	1 pair	1.6 ltr approx 25mm lift
		SUZ 102	1 pair	2 ltr approx 25mm lift
Shock Absorber		G38-5628	1	Gas charged strut (RHS)
		G38-5629	1	Gas charged strut (LHS)
Strut Spacer		10-1091	2	6mm thick for trimming or raising vehicle

Rear Suspension				
Description		Part #	Qty	Notes
Coil Spring		SUZ 108	1 pair	Approx 25mm lift
Shock Absorber		G36-5488	2	Gas charged

Make: SUZUKI

Model: VITARA 4 DOOR INC V6 LWB 1991 - 03/1998 (REF SUZ007K)

Front Suspension				
Description		Part #	Qty	Notes
Coil Spring		SUZ 102	1 pair	Approx 30mm lift
		SUZ 103	1 pair	Approx 25mm lift v6 model
Shock Absorber		G38-5628	1	Gas charged strut (RHS)
		G38-5629	1	Gas charged strut (LHS)
Strut Spacer		10-1091	2	6mm thick for trimming or raising vehicle

Rear Suspension				
Description		Part #	Qty	Notes
Coil Spring		SUZ 109	1 pair	Approx 30mm lift
Shock Absorber		G36-5488	2	Gas charged

Make: TOYOTA

Model: LANDCRUISER FJ/BJ40 1969 - 07/1980 (REF TLCO01K)

Front Suspension

Description		Part #	Qty	Notes
Leaf Spring		TLC 01	2	8 leaf to 80kg constant
Shock Absorber		G36-5560	2	Gas charged
Steering Damper		SD4023	2	Eye/pin - eye/pin
Bush Kit		UK713	1	Urethane bush kit
Fixed Pin		SP346G	2	Greasable pin
Shackle		SK343G	2	Greasable shackle
U/Bolt		UB415	4	Round top U-bolt







Rear Suspension

Description		Part #	Qty	Notes
Leaf Spring		TLC 02	2	7 leaf to 100kg constant
Shock Absorber		G36-5562	2	Gas charged
Bush Kit		UK713	1	Urethane bush kit
Fixed Pin		SP346G	2	Greasable pin
Shackle		SK343G	1	Greasable shackle
U/Bolt		UB415	4	Round top U-bolt

Make: TOYOTA

Model: LANDCRUISER FJ/BJ40 08/1980 - 04/1986 (REF TLC002K)

Front Suspension

Description		Part #	Qty	Notes
Leaf Spring		TLC 04	2	8 leaf to 80kg constant
Shock Absorber		G36-5560	2	Gas charged
Steering Damper		SD4023	2	Eye/pin - eye/pin
Bush Kit		UK719	1	Urethane bush kit
Fixed Pin		SP351G	2	Greasable pin
Shackle		SK353G	2	Greasable shackle
U/Bolt		UB449	1	Driver's side inner square top U-bolt
		UB415	3	Round top U-bolt

Rear Suspension

Description		Part #	Qty	Notes
Leaf Spring		TLC 04R	2	7 leaf to 100kg constant
Shock Absorber		G36-5562	2	Gas charged
Bush Kit		UK719	1	Urethane bush kit
Fixed Pin		SP351G	2	Greasable pin
Shackle		SK353G	1	Greasable shackle
U/Bolt		UB415	4	Round top U-bolt





Make: TOYOTA

Model: LANDCRUISER FJ/HJ45 1969 - 07/1980 (REF TLC003K)

Front Suspension

Description		Part #	Qty	Notes
Leaf Spring		TLC 01	2	8 leaf to 80kg constant
Shock Absorber		G36-5560	2	Gas charged
Steering Damper		SD4023	2	Eye/pin - eye/pin
Bush Kit		UK713	1	Urethane bush kit
Fixed Pin		SP346G	2	Greasable pin
Shackle		SK343G	2	Greasable shackle
U/Bolt		UB415	4	Round top U-bolt

Rear Suspension

Description		Part #	Qty	Notes
Leaf Spring		TLC 03	2	10 (7+3) leaf to 300kg constant
Shock Absorber		G36-5562	2	Gas charged
Bush Kit		UK714	1	Urethane bush kit
Fixed Pin		SP347G	2	Greasable pin
Shackle		SK353LHG	1	Greasable anti inversion shackle
		SK353RHG	1	Greasable anti inversion shackle
U/Bolt		UB416	4	Round top U-bolt





Make: TOYOTA

Model: LANDCRUISER FJ/HJ45,47 08/1980 - 04/1986 (REF TLC004K)

Front Suspension

Description		Part #	Qty	Notes
Leaf Spring		TLC 04	2	8 leaf to 80kg constant
Shock Absorber		G36-5560	2	Gas charged
Steering Damper		SD4023	2	Eye/pin - eye/pin
Bush Kit		UK719	1	Urethane bush kit
Fixed Pin		SP351G	2	Greasable pin
Shackle		SK353G	2	Greasable shackle
U/Bolt		UB449	1	Driver's side inner square top U-bolt
		UB415	3	Round top U-bolt

Rear Suspension

Description		Part #	Qty	Notes
Leaf Spring		TLC 05	2	10 (7+3) leaf to 300kg constant
Shock Absorber		G36-5562	2	Gas charged
Bush Kit		UK719	1	Urethane bush kit
Fixed Pin		SP351G	2	Greasable pin
Shackle		SK353LHG	1	Greasable anti inversion shackle
		SK353RHG	1	Greasable anti inversion shackle
U/Bolt		UB416	4	Round top U-bolt







Make: TOYOTA

Model: LANDCRUISER FJ/HJ 60 08/1980 - 10/1985 (REF TLCO05K)
 LANDCRUISER FJ/HJ 60 11/1985 - 12/1989 (REF TLCO05KA)

Front Suspension

Description		Part #	Qty	Notes
Leaf Spring		TLC 06	2	6 leaf to 60kg constant
Shock Absorber		G36-5563	2	Gas charged
Steering Damper		SD4046	2	Eye/pin - eye/pin
Bush Kit		UK719	1	Urethane bush kit
Fixed Pin		SP351G	2	Greasable pin
Shackle		SK353G	2	Greasable shackle
U/Bolt		UB436	4	Sqaure top U-bolt

Rear Suspension

Description		Part #	Qty	Notes
Leaf Spring		TLC 07D/S	1	7 (6+1) leaf driver's side 300kg constant
		TLC 07N/S	1	7 (6+1) leaf near side 300kg constant
Shock Absorber		G36-5562	2	To 11/1985 gas charged
		G36-5561	2	11/1985 on gas charged
Bush Kit		UK719	1	Urethane bush kit
Fixed Pin		SP351G	2	Greasable pin
Shackle		SK353LHG	1	Greasable anti inversion shackle
		SK353RHG	1	Greasable anti inversion shackle
U/Bolt		UB415	4	Round top U-bolt









Make: TOYOTA
Model: LANDCRUISER FJ/BJ 73 MWB







Front Suspension



Description		Part #	Qty	Notes
Leaf Spring		TLC 08	2	7 leaf modified to 6 leaf, 60kg constant
Shock Absorber		G36-5563	2	Gas charged
Steering Damper		SD4046	2	Eye/pin - eye/pin
Bush Kit		UK719	1	Urethane bush kit
Fixed Pin		SP351G	2	Greasable pin
Shackle		SK353G	2	Greasable shackle
U/Bolt		UB436	4	Sqaure top U-bolt

Rear Suspension

Description		Part #	Qty	Notes
Leaf Spring		TLC 07D/S	1	7 leaf modify to 5+1 leaf to 200kg
		TLC 07N/S	1	7 leaf modify to 5+1 leaf to 200kg
Shock Absorber		G36-5561	2	To 11/1985 gas charged
Bush Kit		UK719	1	Urethane bush kit
Fixed Pin		SP354G	2	Greasable pin
Shackle		SK353LHG	1	Greasable anti inversion shackle
		SK353RHG	1	Greasable anti inversion shackle
U/Bolt		UB415	4	Round top U-bolt







Make: TOYOTA
Model: LANDCRUISER FJ/HJ/HZJ 75 (REF TLCO06K)









Front Suspension				
Description		Part #	Qty	Notes
Leaf Spring		TLC 08	2	7 Leaf to 100kg constant
		TLC 08-8	2	8 leaf 100kg - 150kg constant
		TLC 08P	2	Parabolic option to 80kg
Shock Absorber		G36-5567	2	Gas charged Raised
Steering Damper		SD4046	2	Eye/pin - eye/pin
Bush Kit		UK719	1	Urethane bush kit
Fixed Pin		SP351G	2	Greasable pin
Shackle		SK353G	2	Greasable shackle
		SK353LHG	1	Greasable anti inversion shackle
			1	Greasable anti inversion shackle
		SK359LHG	1	45mm extended shackle
			1	45mm extended shackle
U/Bolt		UB436	4	Sqaure top U-bolt
		UB436HD	4	16mm sqaure top U-bolt (require plate drilling)

Rear Suspension				
Description		Part #	Qty	Notes
Leaf Spring		TLC 09-9	2	9 (7+2) leaf constant 300kg
		TLC 09-10	2	10 (8+2) leaf constant 400kg
		TLC 09-11	2	11 (9+2) leaf constant 500kg
		TLC 09P	2	3 (2+1) leaf parabolic option to 250kg
Shock Absorber		G36-5521	2	Gas charged
Bush Kit		UK720	1	Urethane bush kit
Fixed Pin		SP354G	2	Greasable pin
Shackle		SK353G	2	Greasable shackle
		SK353LHG	1	Greasable anti inversion shackle
			1	Greasable anti inversion shackle
		SK359LHG	1	45mm extended shackle
			1	45mm extended shackle
U/Bolt		UB415	4	Round top U-bolt 210mm long
		UB416	4	Round top U-bolt 230mm long
		UB416HD	4	16mm round top U-bolt (require plate drilling)

Make: TOYOTA

Model: LANDCRUISER HZJ/VDJ 78 (PC) - HZJ/VDJ 79 (CAB CHASSIS) (REF TLC007K)







Front Suspension				
Description		Part #	Qty	Notes
Coil Spring		TLC 107	1 pair	std>30mm to 50kg constant
		TLC 103	1 pair	To 100kg constant
		TLC 103HD	1 pair	100kg - 130kg constant
Coil Spacer		10-1029	2	10mm spacer for raising or trimming vehicle
Shock Absorber		G36-5546	2	Gas charged
		G2491L	2	H/duty hydraulic
Monotube Remote Reservoir Shock Absorber		MXA5-6619P	2	High performance 46mm gas charged adjustable 8 stage
Steering Damper		SD4025	1	Eye/pin - eye/pin VDJ only
		SD4046	1	Eye/pin - eye/pin HZJ only
Castor Bush Kit		10-1004	1	Castor correction kit

Rear Suspension				
Description		Part #	Qty	Notes
Leaf Spring		TLC 12	2	9 (7+2) leaf constant 200kg
		TLC 12-10	2	10 (8+2) leaf constant 300kg
		TLC 12-11	2	11 (9+2) leaf constant 500kg
		TLC 12GVM	2	10 (8+2) leaf up to constant 600kg
		TLC 12-4200	2	10 (8+2) leaf up to constant 700kg
		TLC 12P	2	3 (2+1) leaf parabolic option to 400kg
Shock Absorber		G36-5548	2	Gas charged
		G2492L	2	H/duty hydraulic
Monotube Remote Reservoir Shock Absorber		MXA5-6019P	2	High performance 46mm gas charged adjustable 8 stage
Bush Kit		UK742	1	Urethane bush kit suit OE 14mm pin
		UK742-18	1	Urethane bush kit suit pins and shackles listed
Fixed Pin		SP356-18G	2	Greasable pin
Shackle		SK358-18G	2	Greasable shackle
		SK358-18EXG	2	45mm extended shackle
U/Bolt		UB416	4	Round top U-bolt
		UB416HD	4	16mm round top U-bolt (require plate drilling)
Brake Valve Spacer Block		10-1009	1	Non ABS models







Make: TOYOTA

Model: LANDCRUISER VDJ 76 WAGON 01/2007 on (REF TLCO08K)







Front Suspension





Description		Part #	Qty	Notes
Coil Spring		TLC 107	1 pair	std>30mm to 50kg constant
		TLC 103	1 pair	100kg constant
		TLC 103HD	1 pair	100kg - 130kg constant
Coil Spacer		10-1029	2	10mm spacer for raising or trimming vehicle
Shock Absorber		G36-5546	2	Gas charged
		G2491L	2	H/duty hydraulic
Monotube Remote Reservoir Shock Absorber		MXA5-6619P	2	High performance 46mm gas charged adjustable 8 stage
Steering Damper		SD4025	1	Eye/pin - eye/pin
Castor Bush Kit		10-1004	1	Castor correction kit

Rear Suspension

Description		Part #	Qty	Notes
Leaf Spring		TLC 15	2	6 (4+2) leaf constant 250kg
		TLC 15GVM	2	7 (5+2) leaf constant 350kg
		TLC 15P	2	3 (2+1) leaf parabolic option to 300kg
Shock Absorber		G36-5548	2	Gas charged
		G2492L	2	H/duty hydraulic
Monotube Remote Reservoir Shock Absorber		MXA5-6019P	2	High performance 46mm gas charged adjustable 8 stage
Bush Kit		UK742	1	Urethane bush kit suit OE 14mm pin
		UK742-18	1	Urethane bush kit suit pins and shackles listed
Fixed Pin		SP356-18G	2	Greasable pin
Shackle		SK358-18G	2	Greasable shackle
		SK358-18EXG	1	45mm extended shackle
U/Bolt		UB415	4	Round top U-bolt









Make: TOYOTA
Model: LANDCRUISER FJ/HJ 80, 100, 105 (REF TLC009K)







Front Suspension				
Description		Part #	Qty	Notes
Coil Spring		TLC 108	1 pair	To 45kg constant (std height)
		TLC 106	1 pair	To 60kg constant
		TLC 106HD	1 pair	To 60kg - 90kg constant
Coil Spacer		10-1023	2	10mm spacer for raising or trimming vehicle
		10-1024	2	20mm spacer for raising or trimming vehicle
		10-1025	2	30mm spacer for raising or trimming vehicle
Shock Absorber		G36-5543	2	Gas charged
Steering Damper		SD4046	1	Eye/pin - eye/pin
Castor Bush Kit		10-1004	1	Castor correction kit
Radius Arm Bush		10-1041	1	Radius arm to chassis mount

Rear Suspension				
Description		Part #	Qty	Notes
Coil Spring		TLC 117	1 pair	To 80kg constant (std height)
		TLC 116	1 pair	100kg constant
		TLC 109	1 pair	250kg constant progressive rated coil
		TLC 116HD	1 pair	350kg constant
Coil Spacer		10-1026	2	10mm spacer for raising or trimming vehicle
		10-1027	2	20mm spacer for raising or trimming vehicle
		10-1028	2	30mm spacer for raising or trimming vehicle
Shock Absorber		G36-5550	2	Gas charged
Trailing Arm Bush		10-1042	2	Lower trailing arm bush kit
		10-1043	2	Upper trailing arm bush kit

Make: TOYOTA

Model: LANDCRUISER FJ/HJ 80, 100, 105 3-4" LIFT (REF TLCO010K)



Front Suspension				
Description		Part #	Qty	Notes
Coil Spring		TLC 102HL3	1 pair	To 50kg constant
Coil Spacer		10-1023	2	10mm spacer for raising or trimming vehicle
		10-1024	2	20mm spacer for raising or trimming vehicle
		10-1025	2	30mm spacer for raising or trimming vehicle
Shock Absorber		G40-5543	2	Big bore shock
Steering Damper		SD4046	1	Eye/pin - eye/pin
Castor Bush Kit		10-1040	1	Castor correction kit
Panhard Rod		10-1052	1	Adjustable panhard rod
		10-1052BK	1	panhard rod bush kit
Extended Brake Hose		10-1036	1	Non ABS and single brake hose
Radius Arm Bush		10-1041	1	Radius arm to chassis mount

Rear Suspension				
Description		Part #	Qty	Notes
Coil Spring		TLC 113HL3	1 pair	150kg constant
Coil Spacer		10-1026	2	10mm spacer for raising or trimming vehicle
		10-1027	2	20mm spacer for raising or trimming vehicle
		10-1028	2	30mm spacer for raising or trimming vehicle
Shock Absorber		G40-5550	2	Big bore shock
Panhard Rod		10-1053	1	Adjustable panhard rod
		10-1053BK	1	panhard rod bush kit
Extended Brake Hose		10-1037	1	Non ABS and single brake hose
Trailing Arm Bush		10-1042	2	Lower trailing arm bush kit
		10-1043	2	Upper trailing arm bush kit



Make: TOYOTA

Model: LANDCRUISER 100 SERIES I.F.S PETROL V8 (REF TLCO011K)
 LANDCRUISER 100 SERIES I.F.S TURBO DIESEL (REF TLCO011KA)







Front Suspension





Description		Part #	Qty	Notes
Torsion Bar		TB 1600	1 pair	32mm Ø x 1160mm V8 Petrol and Lexus
		TB 1610	1 pair	32mm Ø x 1210mm 6 cyl Turbo Diesel
Shock Absorber		G36-5552	2	Gas charged
Reinforcing Bracket		10-1054	1	Must be installed with torsion bars

Rear Suspension

Description		Part #	Qty	Notes
Coil Spring		TLC 116	1 pair	Constant 200kg
		TLC 109	1 pair	Constant 200kg – 250kg progressive
		TLC 116HD	1 pair	Constant 300kg
Coil Spacer		10-1026	2	10mm spacer for raising or trimming vehicle
		10-1027	2	20mm spacer for raising or trimming vehicle
		10-1028	2	30mm spacer for raising or trimming vehicle
Shock Absorber		G40-5587	2	Gas charged

Make: TOYOTA
Model: LANDCRUISER 200 SERIES (REF TLCO012K)

Front Suspension				
Description		Part #	Qty	Notes
Coil Spring		TLC 118	1 pair	To 60kg constant
		TLC 118HD	1 pair	70kg - 120kg constant
Shock Absorber		G38-5635	2	Gas charged strut
Monotube Remote Reservoir Shock Absorber		MXA5-6611A50	2	High performance 46mm gas charged adjustable 8 stage
Strut Cap		10-1084	2	Replacement strut top cap
Strut Spacer		10-1092		10mm strut spacer for raising or trimming vehicle
Upper Control Arms		UCA01-02-0-FK	1 pair	

Rear Suspension				
Description		Part #	Qty	Notes
Coil Spring		TLC 119	1 pair	Constant 100kg
		TLC 119HD	1 pair	Constant 250kg
		TLC 119HHD	1 pair	Constant 400kg
Shock Absorber		G40-5587	2	Gas charged
Monotube Remote Reservoir Shock Absorber		MXA5-6011P	2	High performance 46mm gas charged adjustable 8 stage
Pan Hard Rod		10-1056	1	Adjustable

TOYOTA LANDCRUISER 200 SERIES WITH KDSS SYSTEM

Please note when fitting springs to Toyota Landcruiser 200 Series or Lexus LX Series vehicles fitted with Toyota's Kinetic Dynamic Suspension System (KDSS), also referred to by Toyota as a "hydro-mechanical semi active anti roll bar"

Please be advised of the fitting procedure:

1. Suspend vehicle on 2-post type chassis hoist allowing wheels to hang.
2. Locate the KDSS valve housing.

NOTE: The valve housing is located on the left-hand side of the vehicle, on the inside of the chassis rail, roughly halfway between the front and the back of the vehicle.

3. Using a 5mm hex key, open the 2 leveling valves 3 full rotations anti-clockwise. (Access is from underside of the KDSS valve)

NOTE: The KDSS system is now open and the sway bar ends should be able to be freely manipulated with little effort, allowing spring / strut removal and installation.

NOTE: THE VEHICLE MUST NOT BE DRIVEN WITH THESE VALVES OPEN AS THIS WILL COMPROMISE THE SYSTEM AND RENDER THE VEHICLE UNSAFE TO DRIVE.

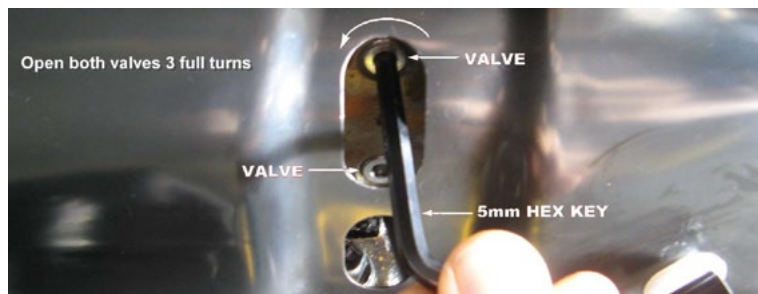





4. With the vehicle sitting on level ground, close both KDSS leveling valves by turning them in a clockwise direction and then tightening.





Make: TOYOTA

Model: LANDCRUISER 300 SERIES (excluding Sahara & GR) 7/2021 on (REF TLC0013K)

Front Suspension

Description		Part #	Qty	Notes
Coil Spring		TLC 220HD	1 pair	Constant 100kg
		TLC 220HHD	1 pair	Constant 100kg - 150kg
Shock Absorber		G38-6001	2	Gas charged
Monotube Remote Reservoir Shock Absorber		MXA5-6634A75	2	High performance 46mm gas charged adjustable 8 stage
Strut Cap		10-1084	2	Replacement strut top cap
Upper Control Arms		UCA01-05-0-FK	1 pair	







Rear Suspension

Description		Part #	Qty	Notes
Coil Spring		TLC 221HD	1 pair	Constant 100kg - 250kg progressive rated coil
		TLC 221EHD	1 pair	Constant 250kg - 400kg progressive rated coil
		TLC 221ELHD	2	Constant 400kg - 500kg
Shock Absorber		G40-5588	2	Gas charged
Monotube Remote Reservoir Shock Absorber		MXA5-6634P75	2	High performance 46mm gas charged adjustable 8 stage
Pan Hard Rod		10-1056	1	Adjustable
Extended Sway Bar Bracket		10-1095	1	Extends mount by 30mm







Make: TOYOTA

Model: HILUX RN46/LN106 LEAF SPRING FRONT AND REAR 1979 - 1/1984 (REF THX001K)
 HILUX RN46/LN106 LEAF SPRING FRONT AND REAR 2/1984 - 1997 (REF THX001KA)

Front Suspension

Description		Part #	Qty	Notes
Leaf Spring		THX 01-6D/S	1	6 leaf RHS front spring to 35kg (diesel)
		THX 01-6N/S	1	6 leaf LHS front spring to 35kg (diesel)
Shock Absorber		G36-5569	2	Gas charged
Steering Damper		SD4021	1	Pin - eye/pin
Bush Kit		UK732	1	Urethane bush kit
Fixed Pin		SP385G	2	Greasable pin
Shackle		SK384G	2	Greasable shackle
		SK384EXG	2	Greasable shackle extended
U/Bolt		UB437	1	Driver's side square top
		UB678	1	Driver's side square forged top
		UB437B	2	Near side square top

Rear Suspension

Description		Part #	Qty	Notes
Leaf Spring		THX 02	2	7 (5+2) leaf constant 250kg
Shock Absorber		G36-5562	2	To 01/1984 gas charged
		G36-5561	2	02/1984 on gas charged
Bush Kit		UK733	1	Urethane bush kit
Fixed Pin		SP385G	2	Greasable pin
Shackle		SK386G	2	Greasable shackle
		SK386EXG	2	Greasable shackle extended
U/Bolt		UB437B	4	Square top U-bolt

Make: TOYOTA

Model: HILUX IFS/LEAF SINGLE, DUAL and EXTRA CAB 08/1988 - 03/2005 (REF THX004K)

Front Suspension

Description		Part #	Qty	Notes
Torsion Bar		TB 1646	1 pair	26mm Ø x 1065mm
Shock Absorber		G36-5538	2	Gas charged
Steering Damper		SD4033	1	Petrol and non turbo diesel models, eye - eye/pin

Rear Suspension

Description		Part #	Qty	Notes
Leaf Spring		THX 04	2	7 (5+2) leaf constant 250kg
Shock Absorber		G36-5521	2	Gas charged
Bush Kit		UK747	1	Urethane bush kit
Fixed Pin		SP385/1	2	14mm pin
Shackle		SK386/1G	2	Greasable shackle
U/Bolt		UB437B	4	Square top U-bolt







Make: TOYOTA

Model: HILUX 4 RUNNER IFS/LEAF REAR LN61, YN63 08/1985 - 1989 (REF THX002K)



Front Suspension



Description		Part #	Qty	Notes
Torsion Bar		TB 1646	1 pair	26mm Ø x 1065mm
Shock Absorber		G36-5538	2	Gas charged
Steering Damper		SD4033	1	Petrol and non turbo diesel models, eye - eye/pin

Rear Suspension



Description		Part #	Qty	Notes
Leaf Spring		THX 02	2	7 (5+2) leaf constant 250kg
Shock Absorber		G36-5561	2	Gas charged
Bush Kit		UK733	1	Urethane bush kit
Fixed Pin		SP385G	2	14mm pin
Shackle		SK386G	2	Greasable shackle
		SK386EXG	2	Greasable shackle extended
U/Bolt		UB437A	4	Square top U-bolt



Make: TOYOTA
Model: 4 RUNNER / SURF 130 CHASSIS (REF THX003K)

Front Suspension				
Description		Part #	Qty	Notes
Torsion Bar		TB 1646	1 pair	26mm Ø x 1065mm
Shock Absorber		G36-5538	2	Gas charged
Steering Damper		SD4033	1	Petrol and non turbo diesel models, eye - eye/pin

Rear Suspension				
Description		Part #	Qty	Notes
Coil Spring		THX 101	1 pair	Constant 100kg
		THX 101HD	1 pair	Constant 175kg
Shock Absorber		G36-5563	2	Gas charged

Make: TOYOTA
Model: SURF 185 CHASSIS (REF TPRO01K)







Front Suspension				
Description		Part #	Qty	Notes
Coil Spring		TPR 101	1 pair	Up to 55kg constant
		TPR 101HD	1 pair	Up to 55kg - 85kg constant
Shock Absorber		G38-5636	2	Gas charged strut
Strut Spacer		10-1091	2	6mm thick for trimming or raising vehicle

Rear Suspension				
Description		Part #	Qty	Notes
Coil Spring		TPR 103	1 pair	Constant 100kg
		TPR 103HD	1 pair	Constant 250kg
Shock Absorber		G36-5585	2	Gas charged





Make: TOYOTA

Model: HILUX KUN 3.0L TD, GGN 4L V6 / VIGO (REF THX005K)







Front Suspension









Description		Part #	Qty	Notes
Coil Spring		TPR 101HD	1 pair	30mm raised to 40kg constant
		TPR 104	1 pair	To 60kg constant
		TPR 104HD	1 pair	70kg - 100kg constant
Shock Absorber		G38-5638	2	Gas charged strut
Monotube Remote Reservoir Shock Absorber		MXA5-4680A50	2	High performance 46mm gas charged adjustable 8 stage
Strut Cap		10-1083	2	Replacement strut top cap
Strut Spacer		10-1091	2	6mm thick for trimming or raising vehicle
Upper Control Arms		UCAB01-01-0	1 pair	

Rear Suspension





Description		Part #	Qty	Notes
Leaf Spring		THX 05	2	6 (4+2) leaf constant 300kg
		THX 05GVM	2	7 (5+2) leaf constant 500kg
		THX 05P	2	3 (2+1) leaf parabolic option constant 300kg
Shock Absorber		G36-5561	2	Gas charged
		G36-5521	2	Gas charged use with THX 05GVM
Monotube Remote Reservoir Shock Absorber		MXA5-4046P	2	High performance 46mm gas charged adjustable 8 stage
Bush Kit		UK766	1	Urethane bush kit
Fixed Pin		SP385/1	2	14mm pin
Shackle		SK387G	2	Greasable shackle
U/Bolt		UB437A	4	Square top U-bolt
Centre Bearing Spacer		CBS02	1	Centre bearing spacer



Make: TOYOTA
Model: HILUX GUN 126, GGN 10/2015 on (REF THX006K)

Front Suspension				
Description		Part #	Qty	Notes
Coil Spring		TPR 104HD	1 pair	To 60kg constant
		TPR 104HHD	1 pair	70kg - 100kg constant
Shock Absorber		G38-5665	2	Gas charged strut
Monotube Remote Reservoir Shock Absorber		MXA5-4680A50	2	High performance 46mm gas charged adjustable 8 stage
Strut Cap		10-1083	2	Replacement strut top cap
Strut Spacer		10-1091	2	6mm thick for trimming or raising vehicle
Upper Control Arms		UCAB01-01-0	1 pair	







Rear Suspension				
Description		Part #	Qty	Notes
Leaf Spring		THX 06	2	6 (4+2) leaf constant 250kg
		THX 06GVM	2	7 (5+2) leaf constant 400kg
		THX 06GVM8	2	8 (6+2) leaf constant 500kg
		THX 06P	2	4 (3+1) leaf parabolic option constant to 250kg
Shock Absorber		G36-5521	2	Gas charged
Monotube Remote Reservoir Shock Absorber		MPA5-6024PL	1	Left side piggy back
		MPA5-6024PR	1	Right side piggy back
Lower Mount Shock Spacer		B-001	1	Optional Spacer Kit for Rear Shocks
Bush Kit		UK766	1	Urethane bush kit
Fixed Pin		SP385/1	2	14mm pin
Shackle		SK391G	2	Greasable shackle
U/Bolt		UB437A	4	Square top U-bolt
		UB437	4	Square top U-bolt use with THX 06GVM8
Centre Bearing Spacer		CBS02	1	Centre bearing spacer



Make: TOYOTA
Model: PRADO 95 SERIES (REF TPRO01K)

Front Suspension				
Description		Part #	Qty	Notes
Coil Spring		TPR 101	1 pair	Up to 55kg constant
		TPR 101HD	1 pair	55kg - 85 kg constant
Shock Absorber		G38-5636	2	Gas charged strut
Strut Cap		10-1086	2	Replacement strut top cap
Strut Spacer		10-1091	2	6mm thick for trimming or raising vehicle







Rear Suspension				
Description		Part #	Qty	Notes
Coil Spring		TPR 103	1 pair	Constant 100kg
		TPR 103HD	1 pair	Constant 250kg
Shock Absorber		G36-5585	2	Gas charged



Make: TOYOTA
Model: PRADO 120 SERIES (REF TPRO02K)

Front Suspension				
Description		Part #	Qty	Notes
Coil Spring		TPR 104	1 pair	Up to 55kg constant
		TPR 104HD	1 pair	55kg - 85kg constant
Shock Absorber		G38-5637	2	Gas charged strut
Monotube Remote Reservoir Shock Absorber		MXA5-6606A50	2	High performance 46mm gas charged adjustable 8 stage
Strut Cap		10-1083	2	Replacement strut top cap
Strut Spacer		10-1091	2	6mm thick for trimming or raising vehicle
Upper Control Arms		UCAB01-02-0	1 pair	

Rear Suspension				
Description		Part #	Qty	Notes
Coil Spring		TPR 105	1 pair	Constant 100kg
		TPR 105HD	1 pair	Constant 250kg
Shock Absorber		G36-5586	2	Gas charged
Monotube Remote Reservoir Shock Absorber		MPA5-6006P	2	High performance 46mm gas charged adjustable 8 stage

Make: TOYOTA
Model: PRADO 150 SERIES (REF TPRO03K)

Front Suspension				
Description		Part #	Qty	Notes
Coil Spring		TPR 104HD	1 pair	Up to 55kg constant
		TPR 104HHD	1 pair	55kg – 85kg constant
Shock Absorber		G38-5637	2	Gas charged strut
Monotube Remote Reservoir Shock Absorber		MXA5-6606A50	2	High performance 46mm gas charged adjustable 8 stage
Strut Cap		10-1083	2	Replacement strut top cap
Strut Spacer		10-1091	2	6mm thick for trimming or raising vehicle
Upper Control Arms		UCAB01-02-0	1 pair	

Rear Suspension				
Description		Part #	Qty	Notes
Coil Spring		TPR 105	1 pair	Constant 100kg
		TPR 105HD	1 pair	Constant 250kg
Shock Absorber		G36-5586	2	Gas charged
Monotube Remote Reservoir Shock Absorber		MPA5-6006P	2	High performance 46mm gas charged adjustable 8 stage

TOYOTA LANDCRUISER PRADO 120/150 SERIES WITH KDSS SYSTEM

Please note when fitting springs to Toyota Landcruiser Prado 120/150 Series fitted with Toyota's Kinetic Dynamic Suspension System (KDSS), also referred to by Toyota as a "hydro-mechanical semi active anti roll bar". This fitting procedure must be strictly adhered to when removal of any suspension component is performed.

FAILURE TO ADHERE TO THIS PROCEEDURE WILL RESULT IN A MALFUNCTION OR DAMAGE TO THE KDSS SYSTEM





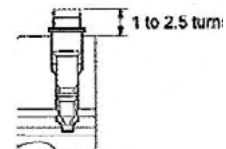

Please be advised of the fitting procedure:

- Suspend vehicle on 2-post type chassis hoist allowing wheels to hang.
- Locate the KDSS accumulator.
NOTE: The valve housing is located on the left-hand side of the vehicle, on the inside of the chassis rail, roughly halfway between the front and the back of the vehicle.
- Remove the steel protective shield.
- Locate shutter valve bolts on the side of the accumulator.
Unscrew the shutter valve bolts 1 ½ - 2 ½ turns MAXIMUM DO NOT REMOVE SHUTTER VALVE BOLTS OR UNSCREW ANY FURTHER THAN ADVISED
- The KDSS system is now open and the sway bar ends should be able to be freely manipulated with little effort, allowing spring / strut removal and installation.
NOTE: THE VEHICLE MUST NOT BE DRIVEN WITH THESE VALVES OPEN AS THIS WILL COMPROMISE THE SYSTEM AND RENDER THE VEHICLE UNSAFE TO DRIVE.
- With the vehicle sitting on level ground, close both KDSS leveling valves by turning them in a clockwise direction and then tightening. Reinstall protective shield.













Make: TOYOTA
 Model: PRADO 250 SERIES (REF TPROOSK)

Front Suspension					Rear Suspension				
Description		Part #	Qty	Notes	Description		Part #	Qty	Notes
Coil Spring 		Coming Soon	1 pair	Up to 55kg constant	Coil Spring 		Coming Soon	1 pair	Constant 100kg
		Coming Soon	1 pair	55kg - 85kg constant			Coming Soon		
Shock Absorber 		Coming Soon							changed
Monoblock Reservoir Shock Absorber									performance in g charged adjustable stage
Strut Cap 				Replacement strut cap					
Strut Spacer 		10-1091	2	6mm thick for trimming or raising vehicle					
Upper Control Arms 		Coming Soon	1 pair						





COMING SOON



Make: TOYOTA
Model: FJ CRUISER (REF TPRO04K)

Front Suspension				
Description		Part #	Qty	Notes
Coil Spring		TPR 104	1 pair	Up to 55kg constant
		TPR 104HD	1 pair	55kg - 85kg constant
Shock Absorber		G38-5637	2	Gas charged strut
Monotube Remote Reservoir Shock Absorber		MXA5-6606A50	2	High performance 46mm gas charged adjustable 8 stage
Strut Cap		10-1083	2	Replacement strut top cap
Strut Spacer		10-1091	2	6mm thick for trimming or raising vehicle
Upper Control Arms		UCAB01-02-0	1 pair	



Rear Suspension				
Description		Part #	Qty	Notes
Coil Spring		TPR 105	1 pair	Constant 100kg
		TPR 105HD	1 pair	Constant 250kg
Shock Absorber		G36-5586	2	Gas charged
Monotube Remote Reservoir Shock Absorber		MPA5-6006P	2	High performance 46mm gas charged adjustable 8 stage





Make: TOYOTA
Model: FORTUNER 07/2015 on (REF TFRO01K)

Front Suspension				
Description		Part #	Qty	Notes
Coil Spring		TPR 104	1 pair	To 60kg constant
		TPR 104HD	1 pair	70kg - 100kg constant
Shock Absorber		G38-5665	2	Gas charged strut
Strut Cap		10-1083	2	Replacement strut top cap
Strut Spacer		10-1091	2	6mm thick for trimming or raising vehicle
Upper Control Arms		UCAB01-01-0	1 pair	

Rear Suspension				
Description		Part #	Qty	Notes
Coil Spring		TFR 100	1 pair	Constant 100kg
		TFR 100HD	1 pair	Constant 250kg
Shock Absorber		G36-5587	2	Gas charged
Centre Bearing Spacer		CBS02	1	Centre bearing spacer







Make: VOLKSWAGEN
Model: AMAROK 2H 2011 - 05/2023 (REF VW001K)

Front Suspension				
Description		Part #	Qty	Notes
Coil Spring		VW 101	1 pair	4CYL
		VW 101H	1 pair	4CYL HD/V6
		VW 101HH	1 pair	V6 HD
Shock Absorber		G38-5655	2	Gas charged strut
Strut Cap		10-1082	2	Replacement strut top cap









Rear Suspension				
Description		Part #	Qty	Notes
Leaf Spring		VW 01	2	6 (4+2) leaf constant 250kg
Shock Absorber		G36-5565	2	Gas charged
Bush Kit		UK780	1	Urethane bush kit
U/Bolt		UB415	4	Round top U-bolt

Make: VOLKSWAGEN
Model: AMAROK NF 06/2023 on (REF FORD006K)

Front Suspension

Description		Part #	Qty	Notes
Coil Spring		FORD 101L	1 pair	2lt Bi Turbo
		FORD 101	1 pair	2lt HD or V6
		FORD 101HD	1 pair	V6 HD
Shock Absorber		G38-5652	2	Gas charged strut
		BSBK-25	2	Bump stop kit
Monotube Remote Reservoir Shock Absorber		MXA5-1615A75L	1	Left side adjustable 8 stage
		MXA5-1615A75R	1	Right side adjustable 8 stage
Strut Cap		10-1080	2	Replacement strut top cap
Strut Spacer		10-1091	2	6mm thick for trimming or raising vehicle
Upper Control Arms		UCAB02-04-0	1 pair	Steel knuckle XL & XLS models only
		UCAB02-05-0	1 pair	Aluminium knuckle XLT, Wildtrack & Platinum

Rear Suspension

Description		Part #	Qty	Notes
Leaf Spring		FORD 01	2	5 (4+1) leaf constant 300kg
		FORD 01HD	2	6 (5+1) leaf constant 400kg
		FORD 01EHD	2	7 (6+1) leaf constant 500kg
Shock Absorber		G36-5566	2	Gas charged
Monotube Remote Reservoir Shock Absorber		MXA5-1015P75L	1	Left side adjustable 8 stage
		MXA5-1015P75R	1	Right side adjustable 8 stage
Bush Kit		UK770	1	Urethane bush kit
Fixed Pin		SP385/1	2	14mm pin
Shackle		SK389G	2	Greasable shackle
U/Bolt		UB437A	4	Square top U-bolt
		UB437	4	Square top U-bolt use with FORD01HD & EHD
Centre Bearing Spacer		CBS03	1	Helps reduce tail shaft vibration



Coil Spring Specifications

Part #	Wire Diameter (mm)	Free Length (mm)	
		Driver's	Passenger
CGL00017A	10.8	355	345
CGL00019	12	375	375
CGP00001	16.5	393	393
CGP00002	16	387	387
DRM 100	18	410	410
DRM 100HD	19	410	410
DRM 110HD	19	480	460
FORD 100	18	370	370
FORD 100HD	18.5	375	375
FORD 101L	18	420	420
FORD 101	18	430	430
FORD 101HD	18.5	430	430
FORD 106	18	470	470
FORD 106HD	18.5	470	470
HOL 101	16	420	420
HOL 101HD	17	420	420
HOL 106	15	405	405
JEEP 100	15	455	455
JEEP 101	15	450	440
JEEP 102	15	450	440
JEEP 103	14	390	380
JEEP 104	16	340	330
JEEP 106	17	360	350
JEEP 107	16	375	375
JEEP 107HD	17	400	390
JEEP 108	17	320	320
JEEP 109	14	450	450
JEEP 111	14.5	460	460
JEEP 112	15	465	465
JEEP 113	14	400	400
JEEP 114	14.5	400	400
JEEP 115	18	345	345
JEEP 116	17	340	330
JEEP 117	17	330	330
JEEP 118	16	320	320
LAN 102	21	410	410
LAN 102HD	22	410	410
LAN 106	16	395	385
LAN 107	16	385	375
LAN 107HD	17	400	390
LAN 108	15	410	390
LAN 112	17	435	425
LAN 113	17	430	420
LAN 113HD	18	425	415
MAZD 100	18	360	360
MAZD 100HD	18.5	365	365
MAZD 100SH	18	340	340
MIT 100	18	325	325
MIT 100HD	19	320	320
MIT 100EHD	20	325	325
MIT 101	17	400	390
MIT 101HD	18	400	390
MIT 102	16	400	390
MIT 103	21	350	340
MIT 103HD	22	330	320
MIT 106	21	335	325
MIT 109	18	320	320
MIT 109H	18	330	330
MIT 109HD	19	320	320
NIS 101	17	405	390
NIS 101HD	18	405	390
NIS 101HL3	18	460	450
NIS 102	16	400	400
NIS 109	19	465	450

Part #	Wire Diameter (mm)	Free Length (mm)	
		Driver's	Passenger
NIS 111	21	485	455
NIS 111SP	21	470	455
NIS 112	14	430	430
NIS 114	18	470	460
NIS 114HD	20	470	460
NIS 114EHD	22	470	460
NIS 114HL3	20	510	495
NIS 116	15	360	360
NIS 126	17	375	375
NIS 126HD	17	360	360
NIS 126HHD	17	375	375
NIS 127	19	445	445
NIS 130	16	450	450
NIS 130HD	17	450	450
SUZ 101	15	290	290
SUZ 102	16	285	285
SUZ 103	16	295	295
SUZ 105	16	335	335
SUZ 106	11.5	350	350
SUZ 108	11.5	345	345
SUZ 109	12.5	335	335
SUZ 111	12.5	360	360
SUZ 112	12	325	305
TFR 100	16	465	465
TFR 100HD	16	480	480
THX 101	16	390	380
THX 101HD	17	370	360
TLC 102HL3	19	515	525
TLC 103	17	460	460
TLC 103HD	18	460	460
TLC 106	17	475	485
TLC 106HD	18	460	470
TLC 107	16	440	440
TLC 108	17	460	470
TLC 109	19	460	470
TLC 113HL3	20	480	490
TLC 116	18	460	470
TLC 116HD	20	460	470
TLC 117	18	455	445
TLC 118	18	430	430
TLC 118H	18	460	460
TLC 118HD	19	430	430
TLC 118HHD	19	450	450
TLC 119	18	450	430
TLC 119HD	19	450	430
TLC 119HHD	20	450	430
TLC 220HD	18	440	440
TLC 220HHD	18	460	460
TLC 221HD	18	455	455
TLC 221EHD	19	455	455
TLC 221ELHD	19	455	455
TPR 101	17	350	350
TPR 101HD	17	365	365
TPR 103	17	390	390
TPR 103HD	18	380	380
TPR 104	17	375	375
TPR 104HD	18	370	370
TPR 104HHD	18	390	390
TPR 105	17	390	390
TPR 105HD	18	390	390
VW 101	18	305	305
VW 101H	18	315	315
VW 101HH	18	325	325



Shock Absorber Reference Chart

Part #	Upper Mount	Lower Mount	Closed (mm)	Open (mm)
G2491L	PIN 14	PIN 14	312	517
G2492L	EB2 - 19ID	EB2 - 19ID	406	666
G36-3204	PIN 10	BARPIN	335	560
G36-3205	CR2 - 12x46	CR2 - 12x36	358	586
G36-3207	CR2 - 16x35	CR1 - 12x36	358	586
G36-3236	BARPIN	EB1 - 16x36	350	565
G36-3237	PIN 10	BARPIN	335	560
G36-3253	PIN 10	EB1 - 12x32	211	304
G36-3293	BARPIN	CR1 - 12x35	343	560
G36-3294	CR1 - 12x46	CR1 - 12x40	348	570
G36-3295	PIN 12	EB1 - 12x40	350	580
G36-3296	BARPIN	CR1 - 12x40	392	650
G36-3297	EB1 - 12x46	CR2 - 12x40	392	650
G36-5481	PIN 10	EB1 - 12x32	268	435
G36-5482	EB1 - 12x32	EB1 - 12x32	302	492
G36-5483	PIN 10	EB1 - 16x36	311	511
G36-5487	EB1 - 16ID	EB1 - 16ID	310	495
G36-5488	PIN 10	EB1 - 16ID	315	510
G36-5491	EB1 - 12x37.5	EB1 - 12x37.5	355	568
G36-5492	PIN 10	EB2 - 12x40	368	613
G36-5521	EB2 - 19ID	EB2 - 19ID	385	630
G36-5522	EB2 - 20ID	EB2 - 12x40	383	633
G36-5523	EB1 - 16ID	EB1 - 16ID	385	630
G36-5524	EB2 - 20 X 48	EB2 - 12X 40	383	633
G36-5526	EB2 - 19ID	PIN 14	390	660
G36-5527	EB2 - 16ID	EB2 - 14x42	366	596
G36-5528	CR2 - 14x48	CR2 - 14x48	273	391
G36-5529	EB2 - 16ID	EB2 - 14x42	355	570
G36-5530	PIN 10	BARPIN	232	350
G36-5535	PIN 10	CR1 - 12x32	245	380
G36-5538	PIN 10	CR2 - 16x38	242	370
G36-5543	PIN 14	PIN 14	365	615
G36-5546	PIN 14	PIN 14	312	517
G36-5548	EB2 - 19ID	EB2 - 19ID	406	666
G36-5550	PIN 14	EB2 - 19ID	370	615
G36-5552	PIN 16	CR2 - 14x40	282	447
G36-5557	CR2 - 19x38	CR2 - 12x48	365	595
G36-5558	CR2 - 12x42	CR2 - 16x42	382	625
G36-5559	EB1 - 16ID	EB1 - 16ID	342	561
G36-5560	EB1 - 16ID	EB1 - 16ID	329	524
G36-5561	EB2 - 19ID	EB2 - 19ID	363	593
G36-5562	EB2 - 16ID	EB2 - 16ID	360	595
G36-5563	PIN 10	EB2 - 19ID	363	595
G36-5563A	PIN 10	EB2 - 16x38	363	595
G36-5563B	PIN 10	EB2 - 14x38	363	605
G36-5565	EB2 - 12x40	EB2 - 12x40	370	600
G36-5566	EB2 - 12x40	EB2 - 12x40	411	660
G36-5567	PIN 10	EB2 - 19ID	365	620
G36-5567B	PIN 10	EB2 - 14x38	365	620
G36-5569	PIN 3/8"	CR1 - 12x32	309	502
G36-5580	PIN 10	CR2 - 16x38	306	486
G36-5582	PIN 10	S/B - 14x48	360	592
G36-5585	PIN 10	EB2 - 19ID	323	530
G36-5586	PIN 12	S/B - 19x45	357	592
G36-5587	PIN 12	S/B - 19x45	371	586
G36-5591	EB2 - 19ID	PIN 14	368	620
G36-5592	PIN 12	PIN 12	347	572
G36-5593	CR3 - 19x40	PIN 12	338	550
G36-5595	EB2 - 14x38	EB2 - 19x44	325	525
G36-5597	EB2 - 16ID	EB2 - 16x38	330	530
G36-5598	CR3 - 12x44	BARPIN	364	590
G36-5599	CR3 - 12x44	CR3 - 12x44	360	571
G36-5600	EB1 - 16ID	EB1 - 16ID	352	579
G36-5601	PIN 18	S/B - 14x62	344	578
G36-5603	EB1 - 16ID	EB1 - 16ID	440	747
G36-5604	PIN 10	CR1 - 12x32	265	413

Shock Absorber Reference Chart (continued)

Part #	Upper Mount	Lower Mount	Closed (mm)	Open (mm)
G36-5607	EB2 - 16ID	EB2 - 12x37	378	620
G38-5624	PIN 10	CR3 - 14x50	340	473
G38-5628	PIN 17	STRUT MOUNT	302	475
G38-5629	PIN 17	STRUT MOUNT	302	475
G38-5635	PIN 17	S/B - 16x39	433	608
G38-5636	PIN 12	S/B - 14x40	346	460
G38-5637	PIN 12	S/B - 14x40	415	555
G38-5638	PIN 12	S/B - 14x40	434	568
G38-5639L	PIN 10	S/B - 14x50	312	430
G38-5639R	PIN 10	S/B - 14x50	312	430
G38-5640	PIN 12	S/B - 14x42	283	385
G38-5641	PIN 11	NO MOUNT	206	313
G38-5642	PIN 12	NO MOUNT	403	561
G38-5643	PIN 12	S/B - 14x40	415	555
G38-5644	PIN 22	STRUT MOUNT	400	590
G38-5644/1	PIN 12	NO MOUNT	430	610
G38-5644/2	PIN 12	NO MOUNT	390	570
G38-5645	PIN 22	STRUT MOUNT	390	570
G38-5645/1	PIN 12	NO MOUNT	420	600
G38-5645/2	PIN 12	NO MOUNT	541	565
G38-5646	PIN 14	STRUT MOUNT	395	595
G38-5647	PIN 14	STRUT MOUNT	360	585
G38-5650	PIN 12	S/B - 16x38	384	505
G38-5651	PIN 12	S/B - 20x50	374	490
G38-5652	PIN 12	BARPIN	378	545
G38-5655	PIN 12	FORK	489	615
G38-5660	PIN 12	S/B - 14x39.2	355	500
G38-5661	PIN 12	S/B - 14x39.2	360	520
G38-5665	PIN 12	S/B - 14x41	434	568
G38-6001	PIN 14	S/B - 24x50	438	623
G40-5543	PIN 14	PIN 14	378	634
G40-5546	PIN 14	PIN 14	330	536
G40-5548	S/B - 19x45	S/B - 19x45	423	689
G40-5550	PIN 14	S/B - 19x45	389	635
G40-5587	PIN 17	S/B - 19x45	408	616
G40-5588	PIN 17	S/B 19x45	431	662
MG-0036P	S/B - 14x41	S/B - 14x41	435	680
MG-0636G50	PIN 12	FORK 16x73.5	390	555
MG-1005P	S/B - 12.7x40	S/B - 12.7x40	460	730
MG-1608G50	PIN 12	BARPIN 12.2x88.8	440	575
SRA02K078	PIN 10	S/B - 12x32	295	440
SRA02K079	S/B - 12x32	S/B - 12x32	331	514
SRA02K084	BARPIN	S/B - 19x44	411	660
SRA03K028	PIN 12	S/B - 14x40	421	550

PIN ## = Pin diameter (mm)
 CR1 ## = COTTON REEL BUSH (mm)
 CR2 ## = COTTON REEL (mm)
 CR3 ## = COTTON REEL (mm)
 EB1 ## = EYE BUSH (mm)
 EB2 ## = EYE BUSH (mm)
 S/B = SILENT BLOCK BUSH

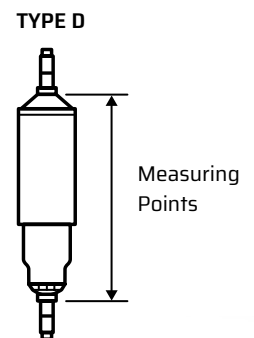
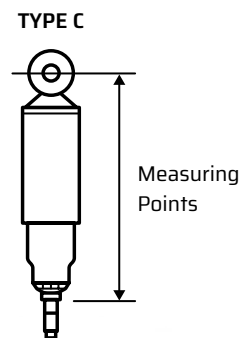
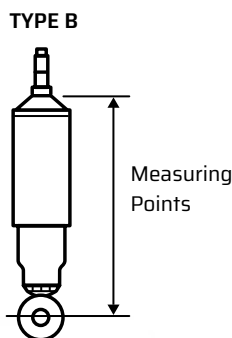
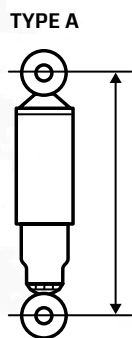

Steering Damper Reference Chart

Part #	Type	Upper Mount	Lower Mount	Open (mm)	Closed (mm)
SD4011	D	PIN	PIN	525	306
SD4012	B	EYE	EYE	655	395
SD4021	C	PIN	EYE/PIN	542	342
SD4022	B	EYE/PIN	EYE	540	325
SD4023	A	EYE/PIN	EYE/PIN	457	320
SD4025	A	EYE/PIN	EYE/PIN	750	440
SD4030	B	EYE	EYE	445	290
SD4033	E	EYE	EYE/PIN	613	363
SD4034	B	EYE	EYE	557	346
SD4035	B	EYE	EYE	493	301
SD4036	D	PIN	PIN	488	290
SD4046	A	EYE/PIN	EYE/PIN	685	424
SD4501	A	EYE/PIN	EYE/PIN	535	335

TYPE A



TYPE B



TYPE C



TYPE D



TYPE E



TYPE F





4WD Shackle Bush Kits

Part #	Contents		
UK701	2xU674T	4xU675	4xU677
UK704	4xU424	8xU426	
UK705	2xU728T	4xU426	
UK710	2xU549	2xU550	4xU611
UK711	4xU549	4xU611	
UK712	4xU611	4xU612	4xU613
UK713	12xU113		
UK714	12xU114		
UK715	4xU675	4xU676	4xU677
UK718	8xU419	4xU420	
UK719	12xU419		
UK720	12xU420		
UK721	4x3050	2xU147T	
UK722	2xU147T	4xU422	4xU423
UK724	2x3050	2xU147T	4xU424
UK728	2xU728T	8xU433	
UK732	4xU432	8xU433	
UK733	12xU433		
UK734	2xU435T	8xU434	
UK742	4xU418	8xU417	4xEBT141886
UK742-18	4xU418	8xU417	
UK747	2xU728T	4xU433	4xU758
UK756	2xU754T	4xU680	4xU753
UK760	2xU760	4xU759	
UK761	2xU761	2xU672	2xU765
UK762	4xU675	4xU677	2xU775
UK763	2xU790T	4xU791	4xU677
UK766	2xU766T	4xU767	4xU768
UK767	2xU728T	4xU426	4xU427
UK768	4xU767	4xU768	4xU776
UK768DC	2xU766T	4xU676	4xU768
UK769	2xU766T	4xU680	4xU753
UK770	2xU683T	4xU681	4xU682
UK771	2xU728T	4xU681	4xU682
UK780	2xU780T	2xU781T	2xU782T or 4xU783
UK867	2xU766T	4xU432	4xU433
UK868	2xU766T	4xU433	4xU792

4WD Suspension U-Bolt Dimensions

Part #	Type	Material	Inside Width	Inside Length
UB258	RND	11	75	190
UB415	RND	14	83	210
UB416	RND	14	83	230
UB416HD	RND	16	83	230
UB417	RND	14	83	250
UB436	SQ	14	72	210
UB436HD	SQ	16	72	210
UB437	SQ	14	62	210
UB437A	SQ	14	62	190
UB437B	SQ	14	62	170
UB449	SQ	14	85	230
UB450	S/RND	16	80	330
UB451	RND	12	75	190
UB452	SQ	12	62	105
UB453	RND	14	95	210
UB464	SQ	14	72	180
UB471	SQ	14	77	230
UB471HD	SQ	16	77	230
UB472	RND	16	90	265
UB473	RND	14	90	200
UB474	SQ	12	72	180
UB654	RND	11	82	160
UB655	RND	11	72	140
UB658	RND	12	65	170
UB659	RND	12	80	170
UB660	SQ	12	62	185
UB663	RND	12	90	220
UB668	SQ	14	72	230
UB670	RND	14	95	230
UB671	RND	14	110	255
UB671HD	RND	16	110	255
UB673	RND	12	70	170
UB674	RND	13	86	190
UB678	SQ FORGED	14	62	210

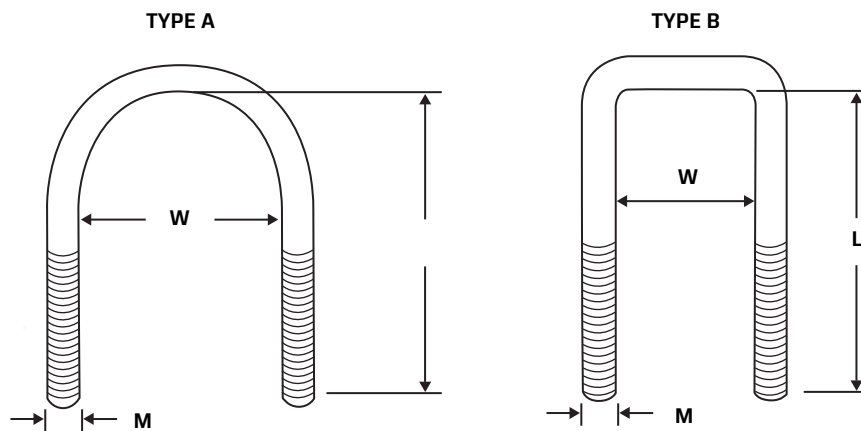

Leaf Spring Specifications

Part #	Type	No. of Leaves	Material		Main Leaf Dimensions		Spring Camber (mm)
			Primary Pack	Secondary Pack	A (mm)	B (mm)	
DAT 03	A	6	60 x 7	N/A	515	640	165
DAT 04	B	5+1	60 x 7	60 x 11	550	625	150
DAT 06	B	5+2	60 x 7	60 x 11	520	710	150
FORD 01	B	4+1	60 x 10 & 8	60 x 16	580	740	120
FORD 01HD	B	5+1	60 x 10 & 8	60 x 16	580	740	120
FORD 29P	A	3	75 x 16 Parabolic	N/A	698	714	105
FORD 33	B	5+1	75 x 9.2 & 8.2	75 x 20	635	845	250
GVM 02	B	4+2	60 x 8	60 x 12	585	740	145
GVM 02HD	B	5+2	60 x 8	60 x 12	585	740	145
HOL 01	B	5+2	60 x 7	60 x 13	550	650	220
HOL 02	B	4+2	60 x 8	60 x 13	600	600	165
HOL 02HD	B	5+2	60 x 8	60 x 13	600	600	165
HOL 03	B	4+2	60 x 8	60 x 13	610	750	165
HOL 03GVM	B	5+2	60 x 8	60 x 13	610	750	165
ISUZU 01	B	3+1	60 x 10 & 8	60 x 18	610	750	150
ISUZU 01HD	B	4+1	60 x 10 & 8	60 x 18	610	750	150
LDV 01	B	4+2	60 x 8	60 x 13	610	750	145
LDV 01HD	B	5+2	60 x 8	60 x 13	610	750	145
MAZD 01	B	5+2	60 x 7	60 x 11	530	675	125
MAZD 01HD	B	6+2	60 x 7	60 x 11	530	675	125
MAZD 02	B	4+2	60 x 8	60 x 12	585	740	115
MAZD 02HD	B	5+2	60 x 8	60 x 12	585	740	115
MAZD 03	B	4+2	60 x 10 & 8	60 x 13	585	745	120
MAZD 03GVM	B	5+2	60 x 10 & 8	60 x 13	585	745	120
MIT 32	B	4+1	70 x 7	70 x 13	520	685	165
MIT 33	B	5+2	70 x 7	70 x 11	520	685	120
MIT 33HD	B	6+2	70 x 7	70 x 11	520	685	120
MIT 34	B	5+2	60 x 8	60 x 13	550	775	120
MIT 34HD	B	6+2	60 x 8	60 x 13	550	775	120
NIS 11	A	7	70 x 7	N/A	550	550	150
NIS 12 D/S-N/S	B	7+2	70 x 7	70 x 13	590	830	180/170
NIS 12P D/S-N/S	B	2+1	70 x 14 Parabolic	70 x 22 Parabolic	590	830	170
NIS 13	B	3+2	60 x 8	60 x 12	565	635	130
NIS 14	B	4+2	60 x 8	60 x 12	655	735	160
NIS 14HD	B	5+2	60 x 8	60 x 12	665	735	160
NIS 15	B	7+2	70 x 10 & 7	70 x 13	590	830	150
NIS 16	B	4+2	60 x 8	60 x 12	665	600	190
SUZI 01	A	4	50 x 7	N/A	470	470	105
SUZI 02	B	3+2	50 x 7	50 x 8	505	505	135
SUZI 03	A	4	50 x 7	N/A	475	475	125
SUZI 05	B	4+1	50 x 7	50 x 10	505	535	155
THX 01-6 D/S-N/S	A	6	60 x 7	N/A	577	577	140/120
THX 02	B	5+2	60 x 7	60 x 11	530	670	180
THX 04	B	5+2	60 x 7	60 x 13	560	740	190
THX 05	B	4+2	60 x 8	60 x 13	610	690	165
THX 05GVM	B	5+2	60 x 8	60 x 13	610	690	145
THX 05P	B	2+1	60 x 12 & 16 Parabolic	60 x 23 Parabolic	610	690	145
THX 06	B	4+2	60 x 8	60 x 13	700	690	160
THX 06GVM	B	5+2	60 x 8	60 x 13	700	690	160
THX 06GVM8	B	6+2	60 x 8	60 x 13	700	690	130
THX 06P	B	3+1	60 x 12.5 & 13.5 Parabolic	60 x 8	700	700	125

Leaf Spring Specifications (continued)

Part #	Type	No. of Leaves	Material		Main Leaf Dimensions		Spring Camber (mm)
			Primary Pack	Secondary Pack	A (mm)	B (mm)	
TLC 01	A	8	70 x 7	N/A	502	603	155
TLC 02	A	7	70 x 7	N/A	502	630	200
TLC 03	B	7+3	70 x 7	70 x 11	660	660	230
TLC 04	A	8	70 x 7	N/A	502	603	155
TLC 04R	A	7	70 x 7	N/A	502	630	200
TLC 05	B	7+3	70 x 7	70 x 11	655	675	230
TLC 06	A	6	70 x 7	N/A	550	550	190
TLC 07 D/S-N/S	B	6+1	70 x 7	70 x 13	565	645	220/205
TLC 08	A	7	70 x 7	N/A	550	590	180
TLC 08-8	A	8	70 x 7	N/A	550	590	180
TLC 08P	A	2	70 x 13 Parabolic	N/A	550	590	185
TLC 09-9	B	7+2	70 x 7	70 x 13	603	720	220
TLC 09-10	B	8+2	70 x 7	70 x 13	603	720	220
TLC 09-11	B	9+2	70 x 7	70 x 13	603	720	220
TLC 09P	B	2+1	70 x 16 Parabolic	70 x 22 Parabolic	608	730	185
TLC 12	B	7+2	70 x 7	70 x 13	690	810	235
TLC 12-10	B	8+2	70 x 7	70 x 13	690	810	235
TLC 12-11	B	9+2	70 x 7	70 x 13	690	810	235
TLC 12-4200	B	8+2	70 x 10 & 7	70 x 13	690	810	210
TLC 12GVM	B	8+2	70 x 10 & 7	70 x 13	690	810	220
TLC 12P	B	2+1	70 x 15 Parabolic	70 x 29 Parabolic	690	810	210
TLC 12PHD	B	3+1	70 x 15 Parabolic	70 x 29 Parabolic	690	810	210
TLC 15	B	4+2	70 x 10 & 7	70 x 13	600	790	210
TLC 15GVM	B	5+2	70 x 10 & 7	70 x 13	600	780	210
TLC 15P	B	2+1	70 x 15 Parabolic	70 x 29 Parabolic	600	780	180
VW 01	B	4+2	70 x 10 & 8	70 x 13	745	745	180

TYPE A
(Single Stage Spring)

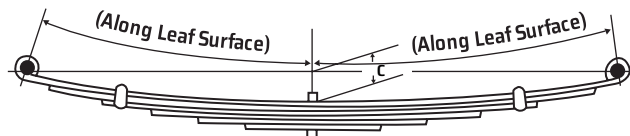

TYPE B
(Two Stage Spring)

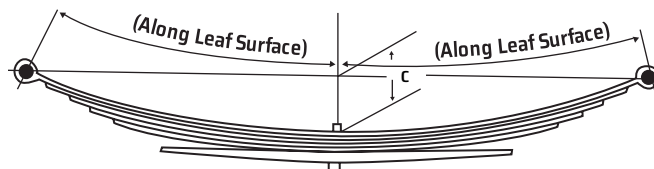

Suspension Installation Form

This form is to be completed and returned to Jenkins Springs within 30 days by the WCS Distributor to validate installation of suspension products.

Date:

Customer Details

Customer Name:

Telephone:

Address:

Suburb / Town: <input type="text"/>	Postcode: <input type="text"/>	State: <input type="text"/>
Vehicle: <input type="text"/>	Model: <input type="text"/>	Month / Year Built: <input type="text"/>
Rego No: <input type="text"/>	Chassis No: <input type="text"/>	Rated GVM: <input type="text"/>

Distributor Name:

Address:

Suburb / Town: <input type="text"/>	Postcode: <input type="text"/>	State: <input type="text"/>
Telephone: <input type="text"/>	Email: <input type="text"/>	

Contact Person:

New Steering Damper Fitted Poly Bushes Fitted—Front Poly Bushes Fitted—Rear

New U-Bolts Fitted: Front Rear

Free height / camber of springs to be fitted

DSF: <input type="text"/>	DSR: <input type="text"/>	NSF: <input type="text"/>	NSR: <input type="text"/>
---------------------------	---------------------------	---------------------------	---------------------------

Place an "X" in the appropriate box to show if accessories are fitted and the position of the accessories

Bull Bar: Alloy Steel Winch Side Bars Power Steering Air Conditioning

Driver Side Front

Shock Part No:

Spring Part No:

Ride Height Before:

Ride Height After:

Driver Side Rear

Shock Part No:

Spring Part No:

Ride Height Before:

Ride Height After:

Rim Size

16 inch

17 inch

Other

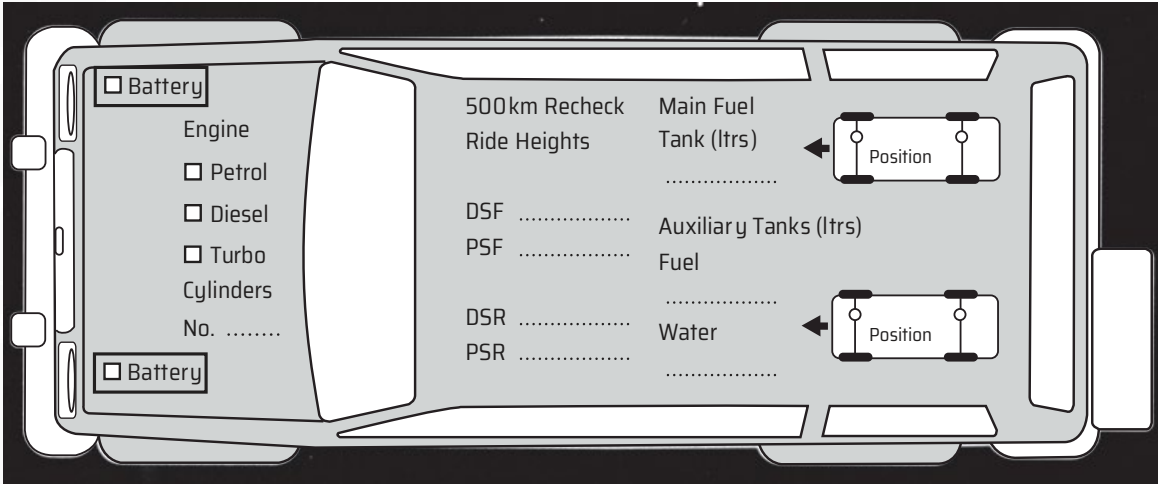

Polyair Bags

Canopy if Ute

Towbar

Roof Rack

Alloy

Steel

Tyre Carrier Position

D/S

CTR

P/S

Near Side Front

Shock Part No:

Spring Part No:

Ride Height Before:

Ride Height After:

Near Side Rear

Shock Part No:

Spring Part No:

Ride Height Before:

Ride Height After:

Warranty Terms and Conditions

Jenkins Springs Pty Ltd trading as West Coast Suspensions—4WD Warranty Statement

West Coast Suspensions (hereafter referred to as WCS) warrant all WCS four-wheel drive parts to the original purchaser for a period of 3 years or 100,000 kilometres whichever occurs first for private vehicles. Commercial and Fleet vehicles warranty is for a period of 1 year or 20,000 kilometres whichever occurs first. Limited warranty would apply to product distributed internationally. This would need to be scheduled at point of purchase. Performance parts such as remote reservoir shocks are warranted for a period of 12 months or 20,000 kilometres.

WCS reserves the right to repair or replace, at their discretion, any product found to be defective in either material or workmanship, within the warranty period, provided the failure or breakage was incurred under conditions of normal use.

No claim for warranty will be entered into when product has been damaged due to; negligent use of product, driver abuse, accident damage or motor sport.

Limited warranty would apply to product distributed internationally, mining and fleet applications. These would need to be scheduled at point of purchase. Furthermore, WCS will not warrant any product when used contrary to that specified by the current WCS catalogues or WCS company personnel.

WCS will not be liable for claims when product has been incorrectly installed or installed to mating parts which are of unacceptable tolerances.

Labour will only be covered under warranty provided the parts were originally fitted by WCS. Claims for labour costs which are incurred by the end user for removal and refit when product was originally installed by the end user will not be entered into.

All costs incurred for freight for the return of failed product or to replace the failed product is the responsibility of the end user (see 'Warranty Procedure' in next column).

WCS accept no responsibility for consequential damages to associated products relating to the failure of the component or injury to any person or persons or possessions. WCS will not be liable for claims for inconvenience caused or commercial loss due to product failure.

WCS reserves the right to modify or change product specification and accept no obligation to provide modification to product previously manufactured and distributed.

Although every effort has been made to ensure that the printed information in the catalogue is correct, WCS must disclaim responsibility for specification and application errors.

It is the responsibility of the end user to establish that the products being purchased comply with local vehicle modification legislation.

West Coast Suspensions—4WD Warranty Procedure

To ensure prompt processing for claims on components deemed to be defective WCS ask that the following procedure be adhered to. Failure to follow procedure could result in a delayed assessment of your warranty claim.

The installer or end user will be required to make contact with WCS Warranty department and inform them of the pending warranty. Once an approval number has been issued the suspect product and relevant documentation (eg. copy of invoice and completed WCS Assessment Form) can be transported to WCS.

Reimbursement for labour costs will be covered only if the parts were originally fitted by WCS. Those claims for labour costs which are incurred by the end user for removal and refit when the product was originally installed by the end user will not be entered into.

Furthermore, the costs incurred for freight for the return of the failed product or to replace failed product is the responsibility of the end user.

The WCS Warranty officer will at his discretion make a decision concerning the claim. The Warranty officer will repair, modify or replace the defective component.

Excluded from warranty will be any item where breakage or premature wear has occurred due to incorrect installation or when components are fitted to mating parts which have unacceptable tolerances.

Read this to save money and time...

Have you ever heard these words "But it was level before you worked on it..." and been unable to dispute them with hard facts? Get the facts before you start pulling the vehicle apart.

Please spend the few minutes it takes to complete this form as this could save you hours of work rectifying a problem that need not have occurred.

All measurements must be taken with the vehicle on level ground. Measurements taken after installation must be done after the vehicle has been road tested and the new parts have settled.

Ride heights are measured in millimetres from the centre of the wheel hub to the wheel arch. If flares are fitted, measure to the lip of the metal part of the guard (see Diagram 1). On some vehicles, (eg. cab chassis) this is not possible or practical. In this instance, measurements should be taken between the bumpstop and its striker plate (see Diagram 2).

If a vehicle measures "lop-sided" at the wheel arch, also check the bumpstop clearances - this will help to determine if the chassis is bent or the body is not true to the chassis. Measure and record on the installation form the free height of the new coils, or the free camber of the new leaves, before fitting to the vehicle. Also take note of the old coils or leaves once removed - are there any discrepancies in the new height/camber? Were the tallest ones on the driver or passenger side? This information is invaluable when sorting problems with vehicles that don't sit level.

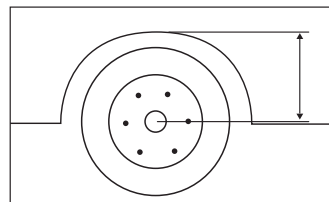

Diagram 1

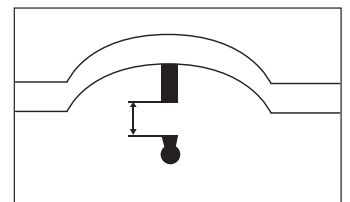

Diagram 2

"COAST TO COAST PERFORMANCE!"

MONOTUBE REMOTE RESERVOIR



Adjustable
8 stage
remote
reservoir

- 46mm bore / seamless inner tube and piston diameter.
- Full floating 46mm piston separating high pressure (150psi) nitrogen gas from hydraulic fluid to eliminate fade and cavitation.
- 52mm outer tube diameter.
- 18mm induction hardened, plated and micro polished piston rod.
- Seamless eye rings.
- Adjustable spring seat height with threaded out body lock rings.
- NOK multi lip oil seals.
- SV-3 anti foaming hydraulic fluid.
- Increased oil capacity at reservoir tank for better heat ventilation and cooling from the shock body.
- 8 Stage adjustable valve setting for ride control at remote tank.
- Light weight impact resistant urethane bellows dust cover.
- Quality rubber mounting bushes.
- Complete installation and fitting kits.
- Long travel for 2" / 50mm lift above OEM ride height.

Make	Model	Part #	Description
Ford	Ranger PX1 & PX2	MXA5-1603A50L	PX1/PX2 Ranger/BT50 Front LHS Strut 0"-2"
		MXA5-1603A50R	PX1/PX2 Ranger/BT50 Front RHS Strut 0"-2"
		MPA5-4045PL	Ranger/BT50 RR Shock 0"-2" Piggy Back (LH)
		MPA5-4045PR	Ranger/BT50 RR Shock 0"-2" Piggy Back (RH)
	Ranger PX3	MXA5-1611A50L	PX3 Ranger Front LH Strut 0"-2"
		MXA5-1611A50R	PX3 Ranger Front RH Strut 0"-2"
		MPA5-4045PL	Ranger/BT50 RR Shock 0"-2" Piggy Back (LH)
		MPA5-4045PR	Ranger/BT50 RR Shock 0"-2" Piggy Back (RH)
	Ranger PY	MXA5-1615A75L	PY Ranger Front LH Strut 0"-3" with Sway Bar Link
		MXA5-1615A75R	PY Ranger Front RH Strut 0"-3" with Sway Bar Link
		MXA5-1015P75L	PY Ranger Rear LH 1.5"-3"
		MXA5-1015P75R	PY Ford Ranger Rear RH 1.5"-3"
Holden/Isuzu	RG Colorado/D-Max	MXA5-9602A50	RG Colorado/D-Max Front 0"-2"
		MPA5-4052PL	RG Colorado/D-Max Rear 0"-2" Piggy Back (LH)
		MPA5-4052PR	RG Colorado/D-Max Rear 0"-2" Piggy Back (RH)
Mazda	BT50 UP/UR	MXA5-1603A50L	PX1/PX2 Ranger/BT50 Front LHS Strut 0"-2"
		MXA5-1603A50R	PX1/PX2 Ranger/BT50 Front RHS Strut 0"-2"
		MPA5-4045PL	Ranger/BT50 RR Shock 0"-2" Piggy Back (LH)
		MPA5-4045PR	Ranger/BT50 RR Shock 0"-2" Piggy Back (RH)
Mitsubishi	Triton ML-MR	MXA5-4686A50	ML/MN/MQ/MR Triton Front 0"-2"
		MXA5-4012P	ML/MN/MQ/MR Triton Rear Shock 0"-2"
Nissan	Navara D40 & D23	MXA5-56110A50	Navara D40/D23 Front 0"-2"
		MPA5-5009PL	Navara D40/D23 Coil Piggy Back Rear Shock (LH)
		MPA5-5009PR	Navara D40/D23 Coil Piggy Back Rear Shock (RH)
	Patrol GU Wagon	MXA5-5001P	Patrol Y60/Y61 Rear 0"-2"
		MXA5-5601P	Patrol Y60/Y61 Front 0"-2"

Make	Model	Part #	Description	
Toyota	Hilux KUN26	MXA5-4680A50	Hilux Front 0"-2"	
		MXA5-4680A75	Hilux Front 1"-3"	
		MPA5-4046PL	Hilux KUN26 Rear 0"-2" Piggy Back (LH)	
			MPA5-4046PR	Hilux KUN26 Rear 0"-2" Piggy Back (RH)
	Hilux GUN126		MXA5-4680A50	Hilux Front 0"-2"
			MXA5-4680A75	Hilux Front 1"-3"
			MPA5-6024PL	Hilux GUN126 Rear Shock 0"-2" Piggy Back (LH)
			MPA5-6024PR	Hilux GUN126 Rear Shock 0"-2" Piggy Back (RH)
	Landcruiser 70 Series		MXA5-6619P	Landcruiser 70 Series Front 0"-2"
			MPA5-6019PL	Landcruiser 70 Series Piggy Back Rear (LH)
			MPA5-6019PR	Landcruiser 70 Series Piggy Back Rear (RH)
	Landcruiser 200 Series		MXA5-6611A50	Landcruiser 200 Series Front 0"-2"
			MXA5-6011P	Landcruiser 200 Series Rear 0"-2"
			MXA5-6611A75	Landcruiser 200 Series Front 1"-3"
			MXA5-6011P75	Landcruiser 200 Series Rear 1"-3"
	Landcruiser 300 Series		MXA5-6634A75	Landcruiser 300 Series Front 1"-3"
			MXA5-6034P75	Landcruiser 300 Series Rear 1"-3"
	Prado 120/150 & FJ Cruiser		MXA5-6606A50	120/150 Prado & FJ Cruiser Front 0"-2"
		MXA5-6606A75	120/150 Prado & FJ Cruiser Front 1"-3"	
		MPA5-6006P	120/150 Prado & FJ Cruiser Rear 0"-2" Piggy Back	

Technical specifications – monotube 2.0 Remote Reservoir

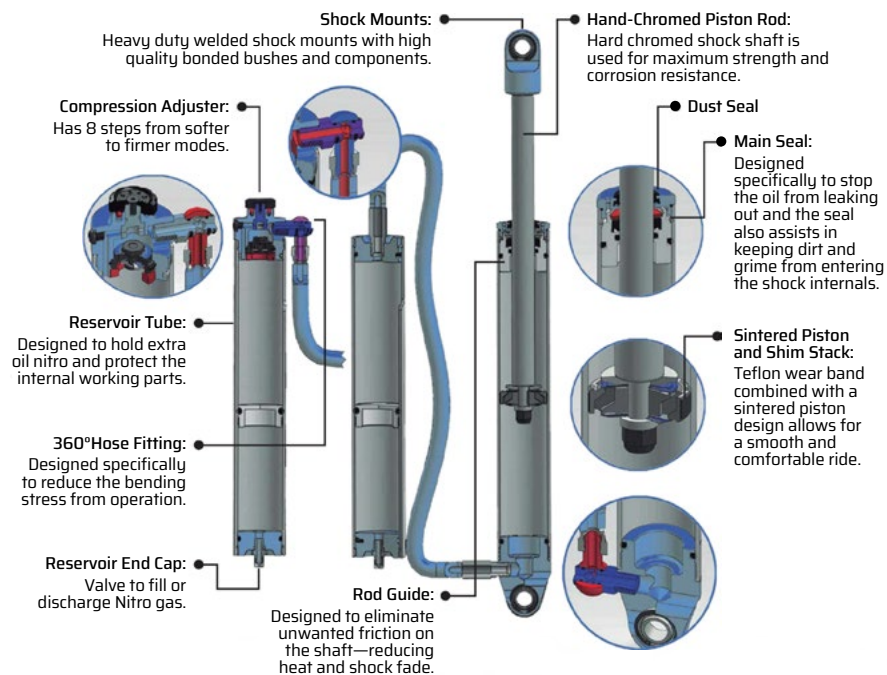

"WHEN PERFORMANCE MATTERS!"

MONOTUBE



0" - 2"

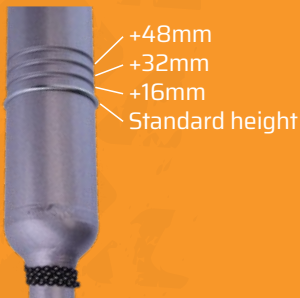

1" - 3"



0" - 2"

- 46mm bore / seamless inner tube and piston diameter.
- Nitrogen gas charged.
- 52mm outer tube diameter.
- 18mm induction hardened, plated and micro polished piston rod.
- Seamless eye rings.
- Adjustable spring seat height.
- NOK multi lip oil seals.
- SV-3 anti foaming hydraulic fluid.
- Light weight impact resistant urethane bellows dust cover.
- Quality rubber mounting bushes.
- Complete installation and fitting kits.
- Long travel for 2" / 50mm lift above OEM ride height.

1" - 3"

- 46mm bore / seamless inner tube and piston diameter.
- Nitrogen gas charged
- 52mm outer tube diameter.
- 18mm induction hardened, plated and micro polished piston rod.
- Seamless eye rings.
- Adjustable spring seat height with 4 circlip retainer grooves.
- Lowest groove setting lifts car 1" with OEM coil spring then each groove up lifts car ¾" to highest groove setting on 4th at 3".
- Do not fit HD lifted coils at upper setting as car will be above 3".
- Front end lift over 2" (50mm) will require new UCA for alignment.
- NOK multi lip oil seals.
- SV-3 anti foaming hydraulic fluid.
- Light weight impact resistant urethane bellows dust cover.
- Quality rubber mounting bushes.
- Complete installation and fitting kits.
- Long travel for 1" - 3" lift above OEM ride height.



Make	Model	Part #	Description
Ford	Everest UA	MX3-1603A75	PX1/PX2 Ranger/BT50 Front 1"-3"
		MX3-1006P75	Everest Rear 1"-3"
	Everest UA2	MX3-1611A75	PX3 Ranger Front 1"-3" ** REUSE OE BUMP STOP **
		MX3-1006P75	Everest Rear 1"-3"
	Everest EK	MX3-1615A75	PY Ranger Front 1"-3" With Sway Bar Link
		MX3-1006P75	Everest Rear 1"-3"
	Ranger PX1 & PX2	MX3-1603A75	PX1/PX2 Ranger/BT50 Front 1"-3"
		MX3-4045P75	Ranger/BT50 Rear 1"-3"
	Ranger PX3	MX3-1611A75	PX3 Ranger Front 1"-3" ** REUSE OE BUMP STOP **
		MX3-4045P75	Ranger/BT50 REAR 1"-3"
	Ranger PY	MX3-1615A75	PY Ranger Front 1"-3" With Sway Bar Link
		MX3-1015P75	PY Ranger Rear 1"-3"
Isuzu	D-Max RT & RG	MX3-9610A75	D-Max/TF BT50 Front 1"-3"
		MX3-9010P75	D-Max/TF BT50 Rear 1"-3"
	MU-X RF & RJ	MX3-9610A75	D-Max/TF BT50 Front 1"-3"
		MX3-9006P75	MU-X Rear 1"-3"
Mazda	BT50 UP & UR	MX3-1603A75	PX1/PX2 Ranger/BT50 Front 1"-3"
		MX3-4045P75	Ranger/BT50 Rear 1"-3"
	BT50 TF	MX3-9610A75	D-Max/TF BT50 Front 1"-3"
		MX3-9010P75	D-Max/TF BT50 Rear 1"-3"
Mitsubishi	Triton ML-MR	MX3-4686A50	ML-MR Triton Front 0"-2"
		MX3-4012P	ML-MR Triton Rear 0"-2"
Nissan	Navara D40 & D23	MX3-56110A75	Navara D40/D23 Front 1"-3"
		MX3-5009P75	Navara D40/D23 Rear 1"-3"
Toyota	Hilux KUN26	MX3-4680A75	Hilux Front 1"-3"
		MX3-4046P75	Hilux KUN Rear 1"-3"
	Hilux GUN126	MX3-4680A75	Hilux Front 1"-3"
		MX3-6024P75	Hilux GUN Rear 1"-3"
	Landcruiser 70 Series	MX3-6619P75	Landcruiser 70 Series Front 1"-3"
		MX3-6019P75	Landcruiser 70 Series Rear 1"-3"
	Landcruiser 200 Series	MX3-6611A75	Landcruiser 200 Series Front 1"-3"
		MX3-6011P75	Landcruiser 200 Series Rear 1"-3"
	Landcruiser 300 Series	MX3-6634A75	Landcruiser 300 Series Front 1"-3"
		MX3-6034P75	Landcruiser 300 Series Rear 1"-3"
Prado 120/150 & FJ Cruiser	MX3-6606A75	Prado 120/150 & FJ Cruiser Front 1"-3"	
	MX3-6006P75	Prado 120/150 & FJ Cruiser Rear 1"-3"	

"DESIGNED FOR OPTIMUM PERFORMANCE"

TWINTUBE GAS CHARGED



- 36mm inner tube and piston diameter.
- Teflon coated piston.
- Seamless inner tube.
- 54mm outer tube diameter
- 16mm induction hardened, plated and micro polished piston rod.
- Seamless eye rings.
- Low pressure nitrogen gas charged.
- NOK multi lip oil seals.
- SV-3 anti foaming hydraulic fluid.
- Increased oil capacity for longer cycle and cooling.
- Light weight impact resistant nylon dust cover.
- Quality rubber mounting bushes.
- Complete installation and fitting kits.
- Long travel for 2" / 50mm lift above OEM ride height.

"HIGH PERFORMANCE COMPONENTS"

UPPER CONTROL ARM (UCA'S)

West Coast Suspension have introduced a series of replacement upper control arm (UCA) for late model IFS vehicles. This replacement UCA program was necessary to ensure that necessary wheel alignment to within manufacturer specifications could be achieved on suspension lifts up to and including 50mm above OEM ride height.



WCS UCA's have been designed and manufactured with the following features:

- Heavy duty Chrome Moly material.
- Heavy duty replaceable ball joint.
- Machined removable Alloy dust cap sealed against water, dust and mud.
- Meet or exceed OEM strength.
- Increased coil clearance on full suspension droop.
- No modifications to vehicle required for WCS UCA fitment.
- Maintains OEM fitment.
- Designed for up to 1" - 3" suspension lift.
- Non adjustable, fixed position ball joint.

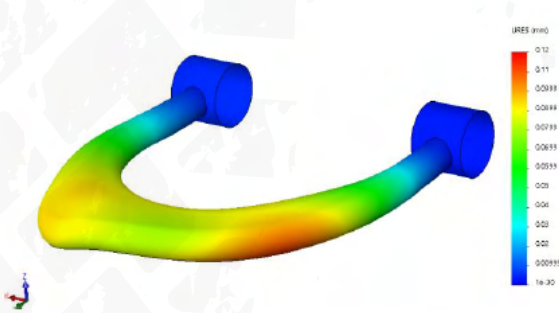

Max Displacement = 0.12 mm

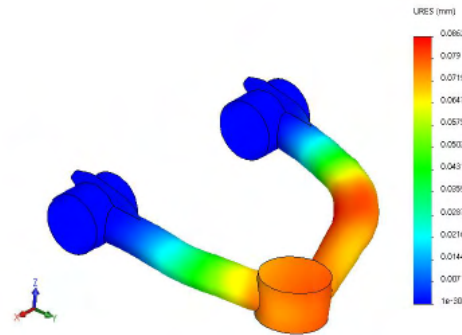

Max Displacement = 0.09 mm

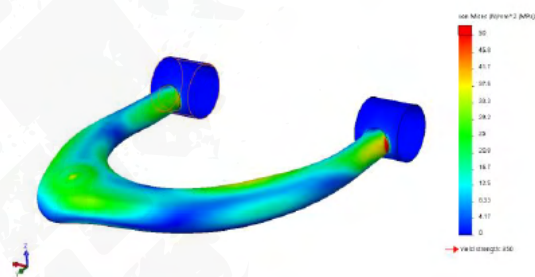

Max Von Mises Stress = 50 MPa

OEM

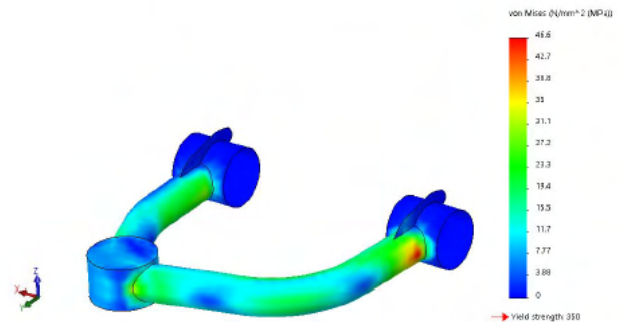

Max Von Mises Stress = 46.5 MPa

AFTER MARKET

WCS UCA's have been designed and manufactured to be ADR compliant. However, there are no specific rules within the ADR to cover UCA's. WCS UCA's maintain OEM fitment position and exceed the strength of OEM UCA's. Ensuring a perfect fit, steering geometry adjustability and long service life with replaceable components withing OEM specification.

Part #	Description
UCA01-02-0	UCA 200 SERIES CRUISER
UCA01-05-0-FK	UCA 300 SERIES CRUISER
UCA02-03-0-FK	UCA FORD F150
UCA03-01-0-FK	UCA GMC 1500
UCA09-01-0-FK	UCA DODGE RAM 2020>
UCAB01-01-0	UCA HILUX / FORTUNER
UCAB01-02-0	UCA PRADO / FJ CRUISER
UCAB02-01-0	UCA FORD RANGER / EVEREST > 05/2022
UCAB02-04-0	UCA RANGER/EVEREST FROM 05/2022 STEEL KNUCKLE
UCAB02-05-0	UCA RANGER/EVEREST FROM 05/2022 ALU KNUCKLE
UCAB04-01-0	UCA NISSAN NAVARA
UCAB-05-01-0	UCA TRITON ML-MN / PAJERO
UCAB-05-01-IT	UCA TRITON MQ-MR / PAJERO
UCAB06-01-0	UCA D-MAX 2012>08-20 / COLORADO 2012-2016
UCAB06-02-0	UCA D-MAX - MUX 08-20> / BT50 2021>